

□

## Adafruit LED Backpacks

Created by lady ada

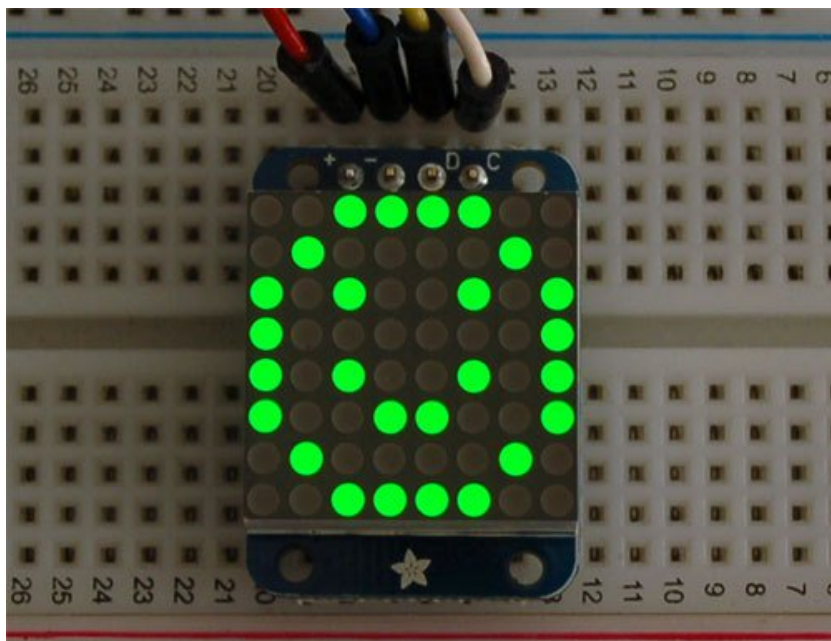

Last updated on 2016-12-30 04:06:36 PM UTC

## Guide Contents

Guide Contents	2
Overview	4
1.2" 8x8 Matrix	8
( <a href="http://adafru.it/aPT">http://adafru.it/aPT</a> )Mini 8x8 Matrix Software	12
0.8" 8x8 Matrix	15
Mini 8x8 Matrix Software	19
0.54" Alphanumeric	22
Attaching the Backpack	22
Attaching Header	27
Prepare the header strip:	28
Add the Backpack:	28
Downloading the Arduino Library	29
Wiring!	29
Load Demo	30
Library Reference	32
ASCII data	33
Writing Data	34
0.56" 7-Segment Backpack	35
Seven-Segment Backpack Firmware	38
1.2" 7-segment Backpack	42
Arduino Wiring - R3 and later	47
Arduino Due and Other 3.3v Processors	47
Arduino "Classic" Wiring	48
Seven-Segment Backpack Firmware	48
Bi-Color 8x8 Matrix	51
Bi-Color 8x8 LED Backpack Firmware	55
Schematic	57
Bi-Color 24 Bargraph	58
Attaching the bar-graph modules	59
Soldering on breadboard pins	63
Bi-Color Bargraph LED Backpack Wiring & Firmware	65
Connecting Multiple Backpacks	69

Wire it Up	70
Configure the Address	70
Changing I2C Address	72
Changing Addresses	72
Changing the address in your code	73
F.A.Q.	75
Downloads	76
Software	76
Files	76
HT16K33 8x16 LED Backpack Breakout	76
8x8 0.8" LED Backpack	78
8x8 1.2" LED Backpack	80
8x8 1.2" Bi-Color LED Backpack	82
16x8 1.2" LED Backpacks	83
Quad 0.56" 7-Segment	84
Quad 0.54" 14-segment Alphanumeric	85
Quad 1.2" 7-Segment	86
Bicolor 24-Bargraph	87



# Overview

What's better than a single LED? Lots of LEDs! A fun way to make a small display is to use an [8x8 matrix](http://adafru.it/aLG) (http://adafru.it/aLG) or a [4-digit 7-segment display](http://adafru.it/aLH) (http://adafru.it/aLH).

Matrices like these are 'multiplexed' - so to control 64 LEDs you need 16 pins. That's a lot of pins, and there are [driver chips like the MAX7219](http://adafru.it/453) (http://adafru.it/453) that can control a matrix for you but there's a lot of wiring to set up and they take up a ton of space. Here at Adafruit we feel your pain! After all, wouldn't it be awesome if you could control a matrix without tons of wiring? That's where these adorable LED matrix backpacks come in.

We have them in quite a few flavors!

- [Adorable Mini 8x8](http://adafru.it/ttf) (http://adafru.it/ttf)
- [Classic 1.2" 8x8 \(round and square dots\)](http://adafru.it/ttA) (http://adafru.it/ttA)
- [4-digit 0.56" 7-segment](http://adafru.it/ttB) (http://adafru.it/ttB)
- [4-digit 1.2" 7-segment](http://adafru.it/ttC) (http://adafru.it/ttC)
- [4-digit 0.54" 14-segment Alphanumeric](http://adafru.it/ttD) (http://adafru.it/ttD)
- [Bi-color 8x8](http://adafru.it/902) (http://adafru.it/902)
- [Bi-color Bargraph](http://adafru.it/1721) (http://adafru.it/1721)

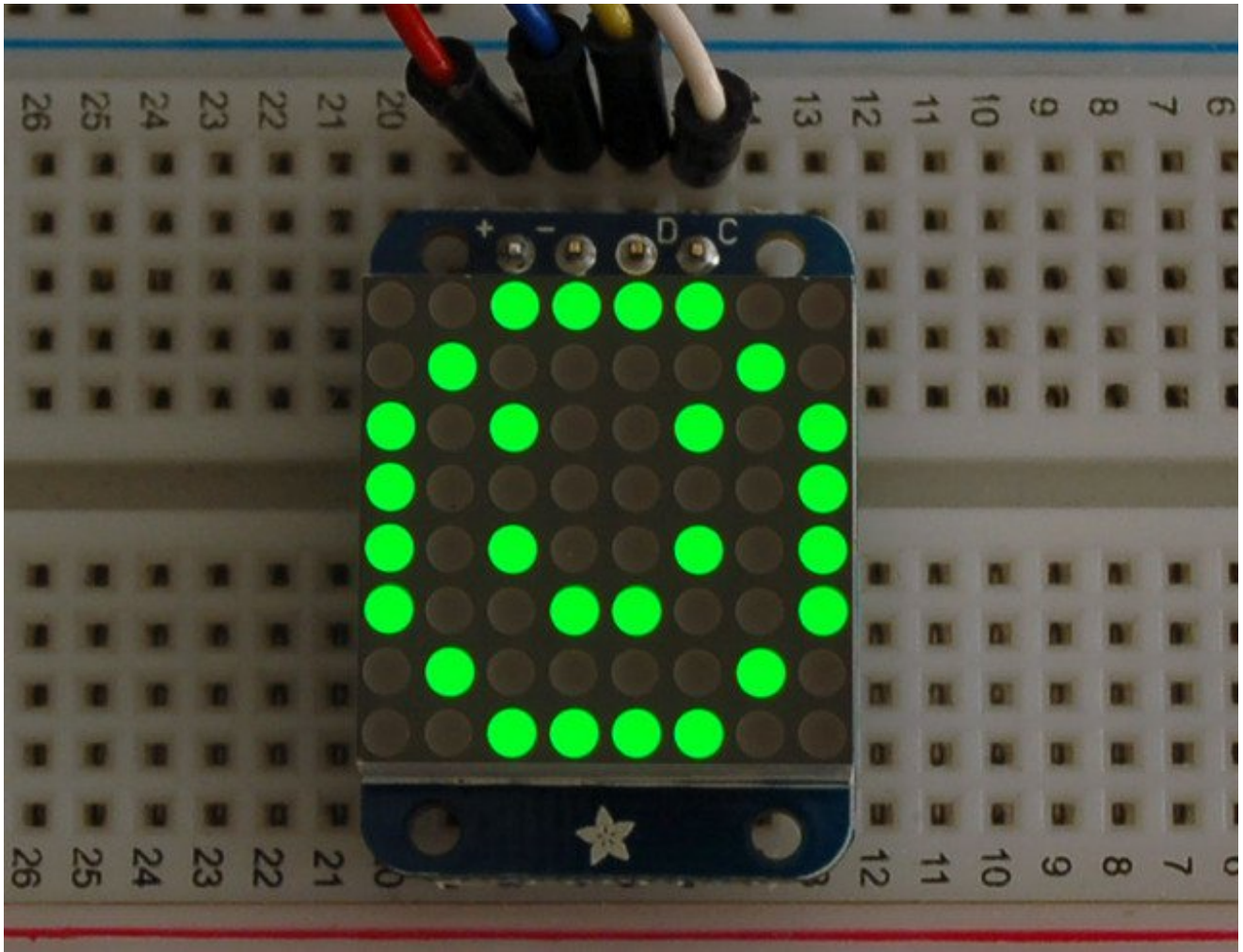

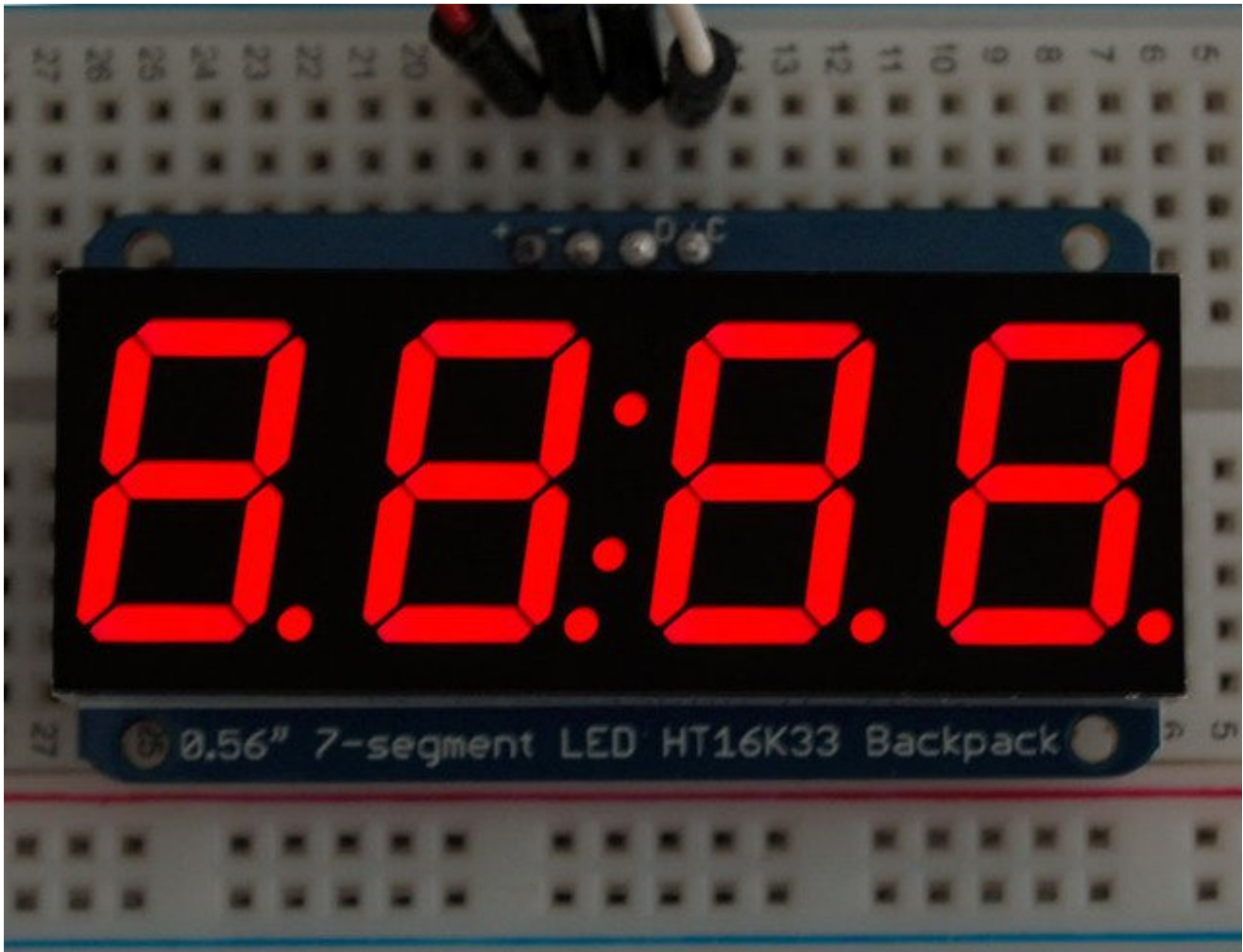



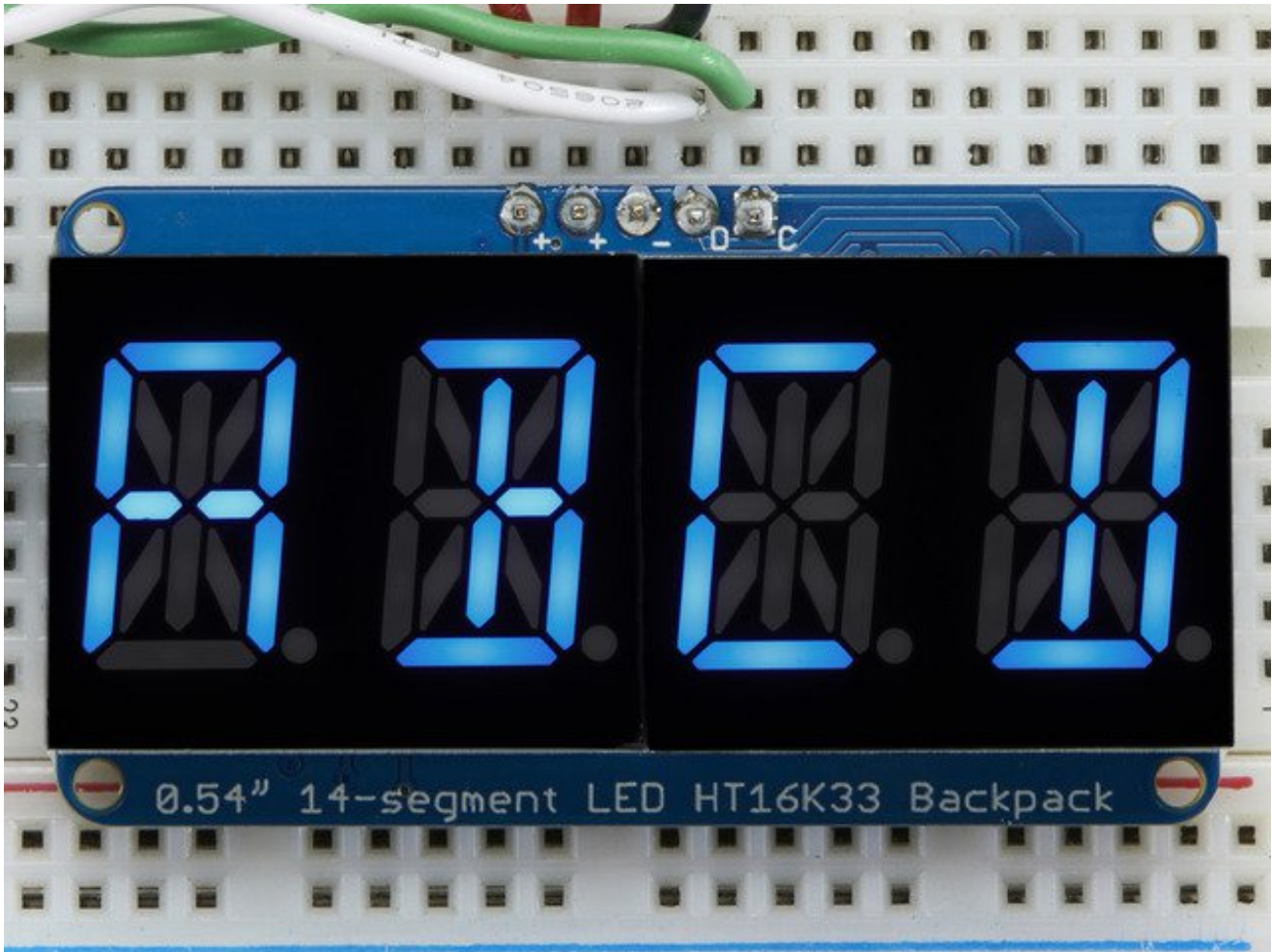

The matrices use a driver chip that does all the heavy lifting for you: They have a built in clock so they multiplex the display. They use constant-current drivers for ultra-bright, consistent color (the images above are photographed at the dimmest setting to avoid overloading our camera!), 1/16 step display dimming, all via a simple I2C interface. The backpacks come with address-selection jumpers so you can connect up to four mini 8x8's or eight 7-segments (or a combination, such as four mini 8x8's and four 7-segments, etc) on a single I2C bus.

The product kit comes with a fully tested and assembled LED backpack, a 4-pin header and the matrix of your choice. A bit of soldering is required to attach the matrix onto the backpack but its very easy to do and only takes about 5 minutes.

Of course, in classic Adafruit fashion, we also have a detailed tutorial showing you how to solder, wire and control the display. We even wrote a very nice library for the backpacks so you can get running in under half an hour, displaying images on the matrix or numbers on the 7-segment. If you've been eyeing matrix displays but hesitated because of the complexity, his is the solution you've been looking for!

# 1.2" 8x8 Matrix

This version of the LED backpack is designed for the 1.2" 8x8 matrices. They measure only 1.2"x1.2" so its a shame to use a massive array of chips to control it. This backpack solves the annoyance of using 16 pins or a bunch of chips by having an I2C constant-current matrix controller sit neatly on the back of the PCB. The controller chip takes care of everything, drawing all 64 LEDs in the background. All you have to do is write data to it using the 2-pin I2C interface. There are two address select pins so you can select one of 8 addresses to control up to 8 of these on a single 2-pin I2C bus (as well as whatever other I2C chips or sensors you like). The driver chip can 'dim' the entire display from 1/16 brightness up to full brightness in 1/16th steps. It cannot dim individual LEDs, only the entire display at once.

These instruction apply to the 1.2" Matrix only! If you have a Bi-Color or 0.8" square matrix, follow the links on the left side of the page.

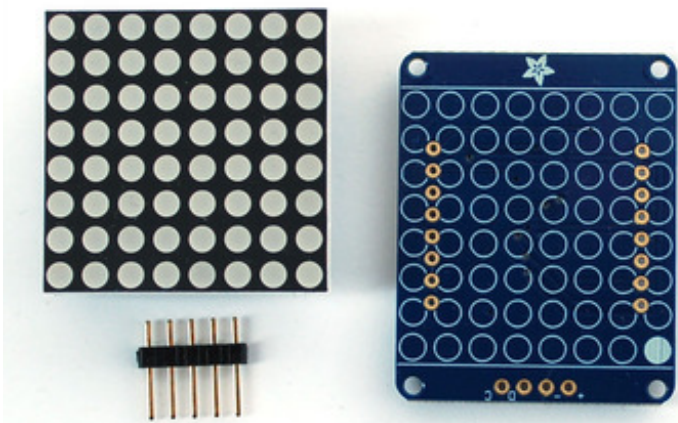

When you buy a pack from Adafruit, it comes with the fully tested and assembled backpack as well as a 8x8 matrix in one of the colors we provide (say, red, yellow or green). You'll need to solder the matrix onto the backpack but its an easy task.

## WATCH OUT! THE MATRIX



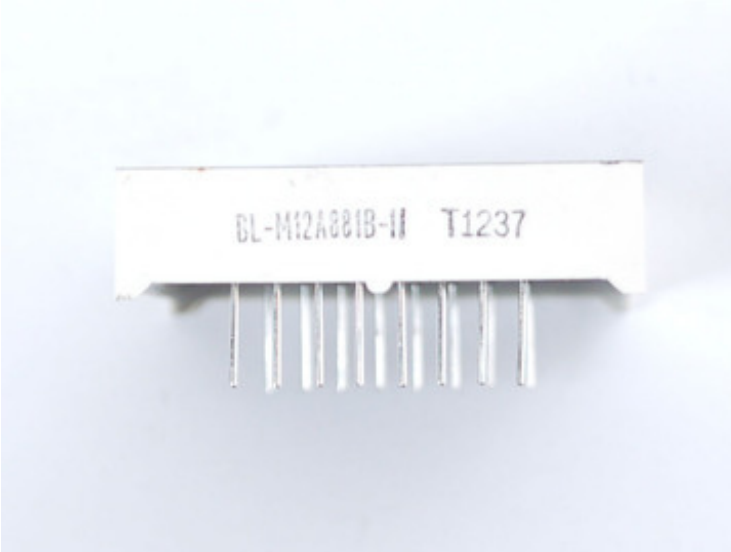

**MUST BE INSTALLED THE RIGHT WAY!**

First look for the line of text on the side of the LED matrix

•

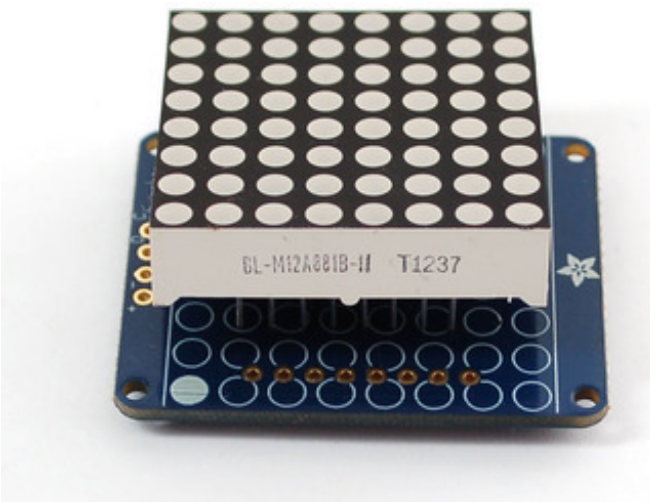

**WATCH OUT! THE MATRIX MUST BE INSTALLED THE RIGHT WAY!**

Find the corner of the backpack with a filled in dot. Make sure that the text on the side of the matrix is on the same side as the filled dot

•

**WATCH OUT! THE MATRIX MUST BE INSTALLED THE RIGHT WAY!**

Slide the matrix into the backpack and flip it over. Triple check that the text is on the same side as the **From Adafruit** text

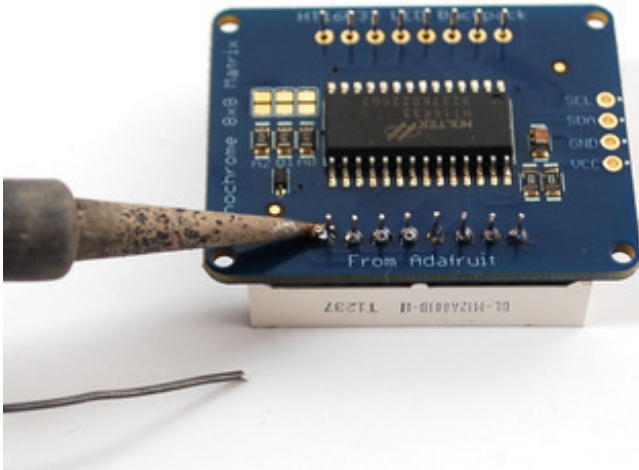

- 
- 

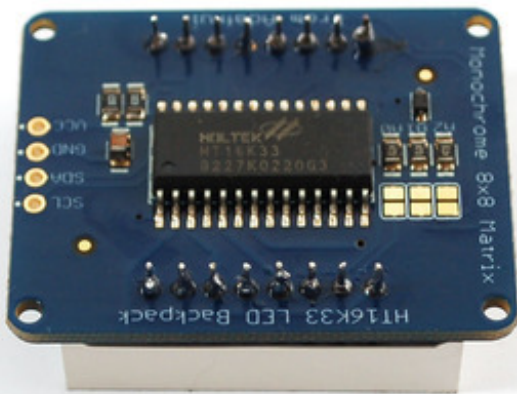

Solder in all 16 pins

Then clip the matrix leads short

- 

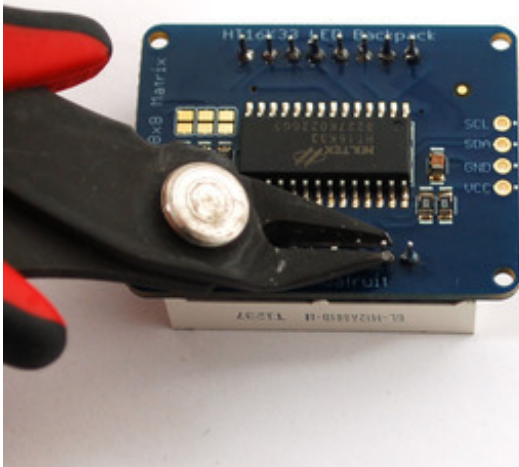

-

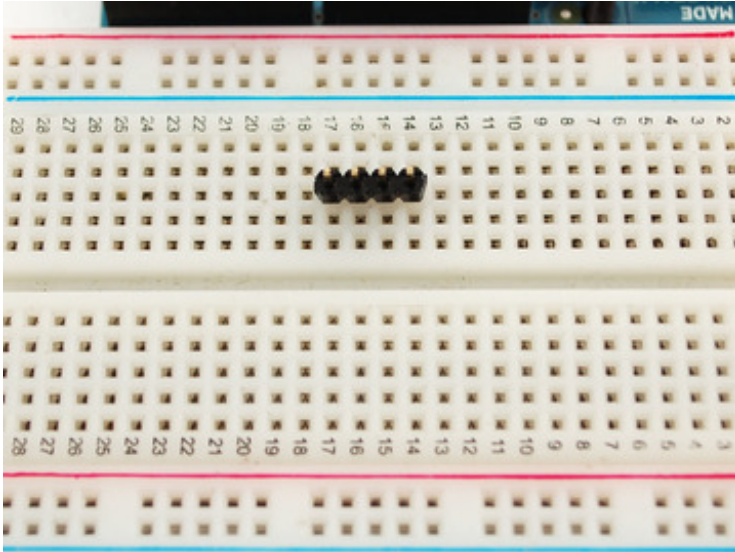

Now you're ready to wire it up to a microcontroller. We'll assume you want to use a 4pin header. You can also of course solder wires directly. Place a 4-pin piece of header with the LONG pins down into the breadboard.

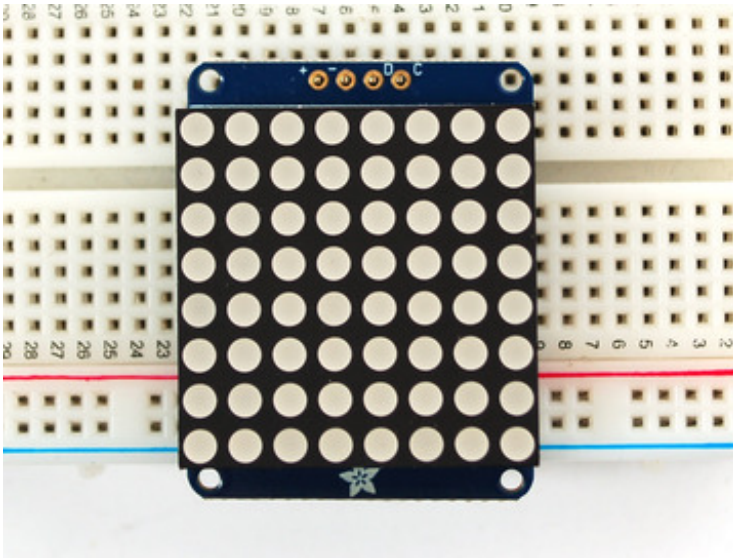

Place the soldered backpack on top of the header.

Solder the four pins

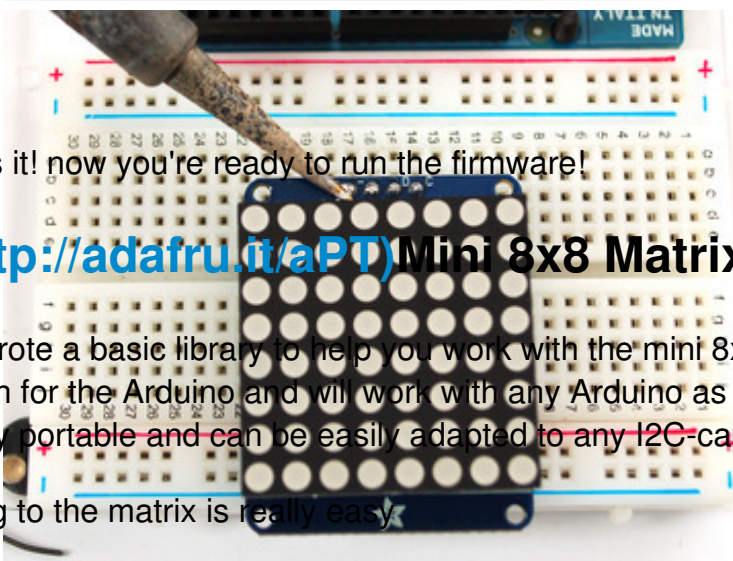

That's it! now you're ready to run the firmware!

## <http://adafruit.it/aPT> Mini 8x8 Matrix Software

We wrote a basic library to help you work with the mini 8x8 matrix backpack. The library is written for the Arduino and will work with any Arduino as it just uses the I2C pins. The code is very portable and can be easily adapted to any I2C-capable micro.

Wiring to the matrix is really easy.

- Connect **CLK** to the I2C clock - on Arduino UNO thats Analog #5, on the Leonardo its Digital #3, on the Mega its digital #21
- Connect **DAT** to the I2C data - on Arduino UNO thats Analog #4, on the Leonardo its Digital #2, on the Mega its digital #20
- Connect **GND** to common ground
- Connect **VCC+** to power - 5V is best but 3V also seems to work for 3V microcontrollers.

Next, [download the Adafruit LED Backpack library from github \(http://adafruit.it/aLI\)](http://adafruit.it/aLI) . To download click the DOWNLOADS button in the top right corner, rename the uncompressed folder **Adafruit\_LEDBackpack**. Check that the **Adafruit\_LEDBackpack** folder contains **Adafruit\_LEDBackpack.cpp** and **Adafruit\_LEDBackpack.h** Place the **Adafruit\_LEDBackpack** library folder your *arduinofolder/libraries/* folder. You may need to create the *libraries* subfolder if its your first library. [You'll also need to download the Adafruit GFX library \(http://adafruit.it/aJa\)](http://adafruit.it/aJa) that provides the graphics drawing routines. Restart the IDE.



Once you've restarted you should be able to select the **File->Examples->Adafruit\_LEDBackpack->matrix88** example sketch. Upload it to your Arduino as usual. You should see a basic test program that goes through a bunch of different drawing routine

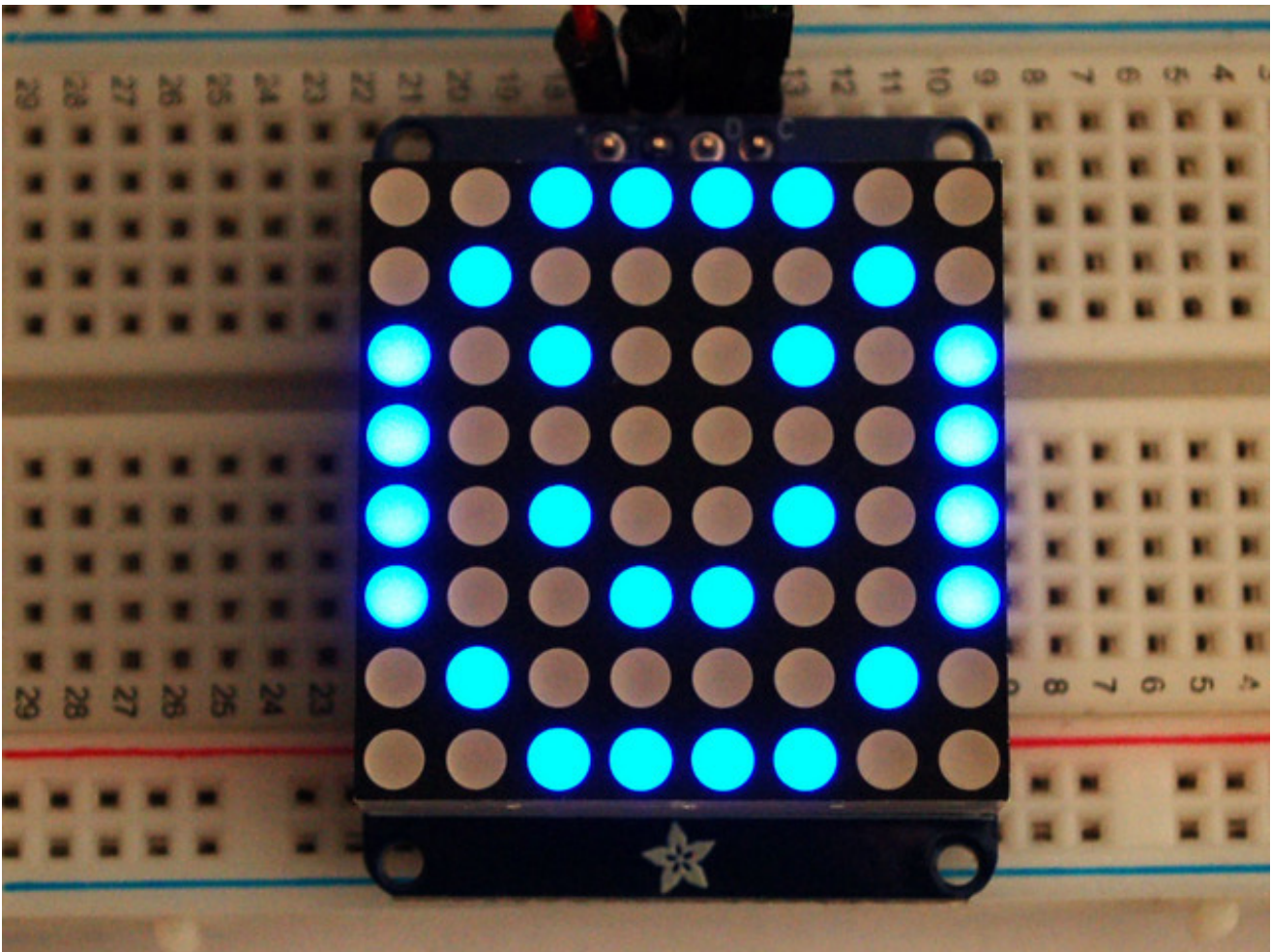

Once you're happy that the matrix works, you can write your own sketches. The 8x8 matrix supports everything the Adafruit GFX library - drawing pixels, lines, rectangles, circles, triangles, roundrects, and small bitmaps. [For more details check out the GFX page which will detail all of the GFX routines \(http://adafru.it/aPx\).](http://adafru.it/aPx)

All the drawing routines only change the display memory kept by the Arduino. Don't forget to call **writeDisplay()** after drawing to 'save' the memory out to the matrix via I2C.

There are also a few small routines that are special to the matrix:

- **setBrightness(*brightness*)**- will let you change the overall brightness of the entire display. 0 is least bright, 15 is brightest and is what is initialized by the display when you start. You can call this function at any time to change the brightness of the - entire- display



- **blinkRate(*rate*)** - You can blink the entire display. 0 is no blinking. 1, 2 or 3 is for display blinking. You can call this function at any time to change the blink rate of the entire display

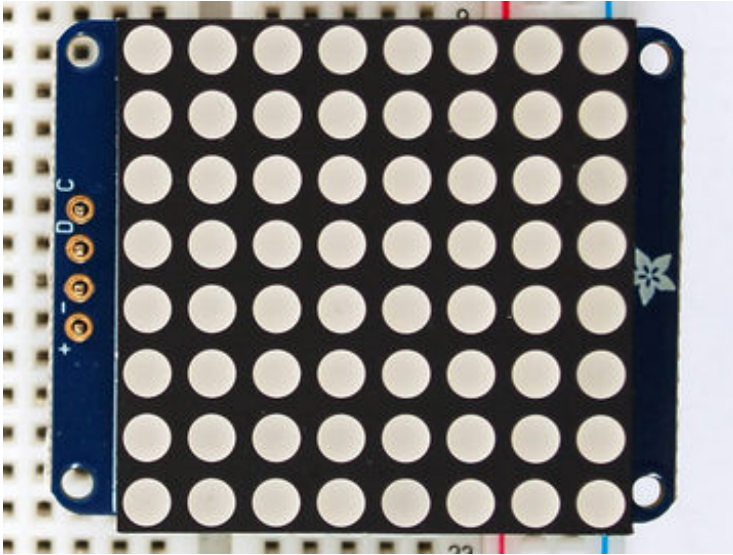

The default orientation for graphics commands on this display places pixel (0,0) at the top-left when the header is at the left and Adafruit logo at the right. To use the matrix as shown above (header at top, logo at bottom), call `matrix.setRotation(3)` before issuing graphics commands.

# 0.8" 8x8 Matrix

This version of the LED backpack is designed for these very cute miniature 8x8 matrices. They measure only 0.8"x0.8" so its a shame to use a massive array of chips to control it. This backpack solves the annoyance of using 16 pins or a bunch of chips by having an I2C constant-current matrix controller sit neatly on the back of the PCB. The controller chip takes care of everything, drawing all 64 LEDs in the background. All you have to do is write data to it using the 2-pin I2C interface. There are two address select pins so you can select one of 4 addresses to control up to 4 of these on a single 2-pin I2C bus (as well as whatever other I2C chips or sensors you like). The driver chip can 'dim' the entire display from 1/16 brightness up to full brightness in 1/16th steps. It cannot dim individual LEDs, only the entire display at once.

These instruction apply to the 0.8" Matrix only! If you have a Bi-Color or 1.2" square matrix, follow the links on the left side of the page.

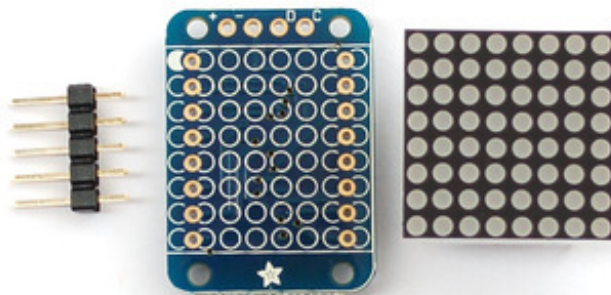

When you buy a pack from Adafruit, it comes with the fully tested and assembled backpack as well as a 8x8 matrix in one of the colors we provide (say, red, yellow or green). You'll need to solder the matrix onto the backpack but its an easy task.

•

Remove the parts from packaging and place the LED

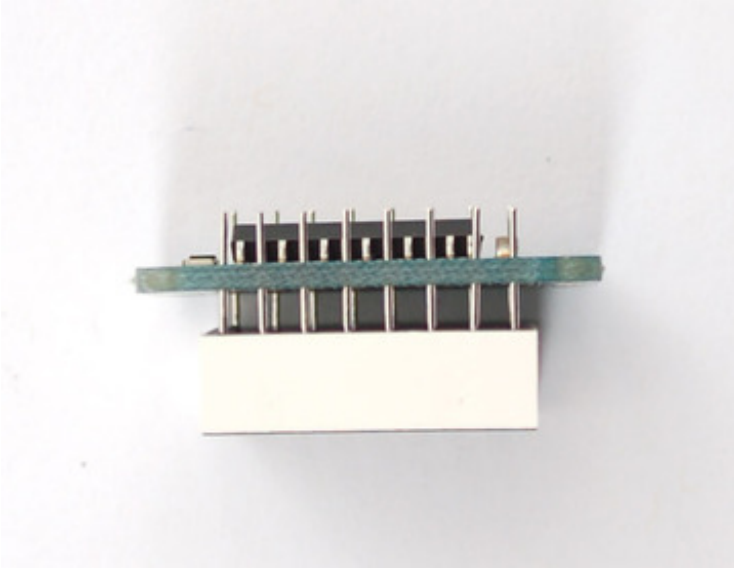

matrix OVER the silkscreen side. It can go 'either way' - the matrix is symmetric so as long as it goes onto the front it will work in any orientation. Do not solder the matrix over the chip on the back of the backpack - it will not work then!

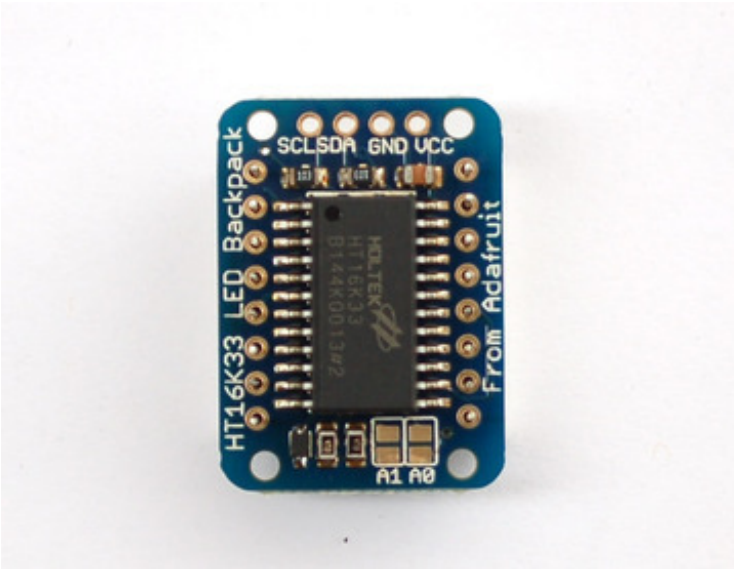

Turn the backpack over so its sitting flat on the matrix.

Solder all 16 pins.

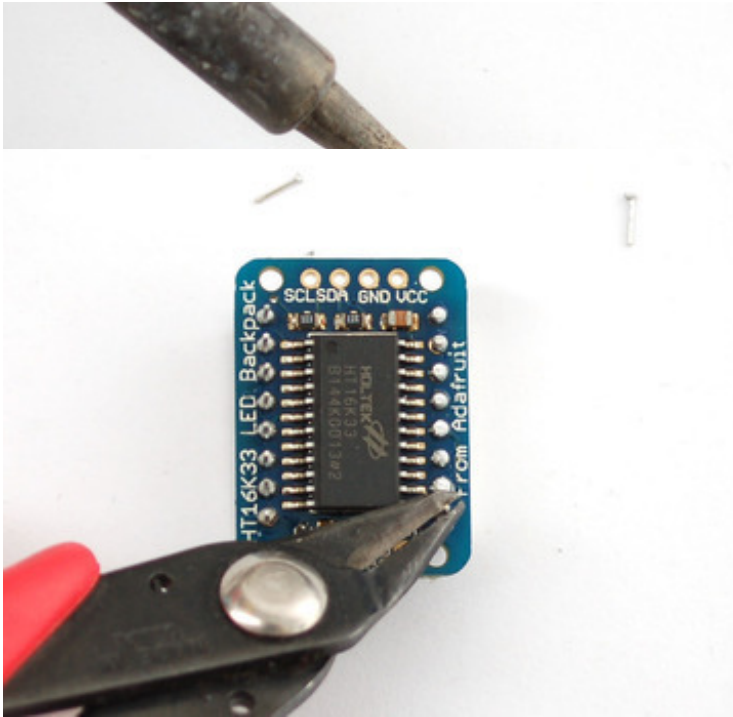

- 
- 



- 

Clip the long pins.

Now you're ready to wire it up to a microcontroller. We'll assume



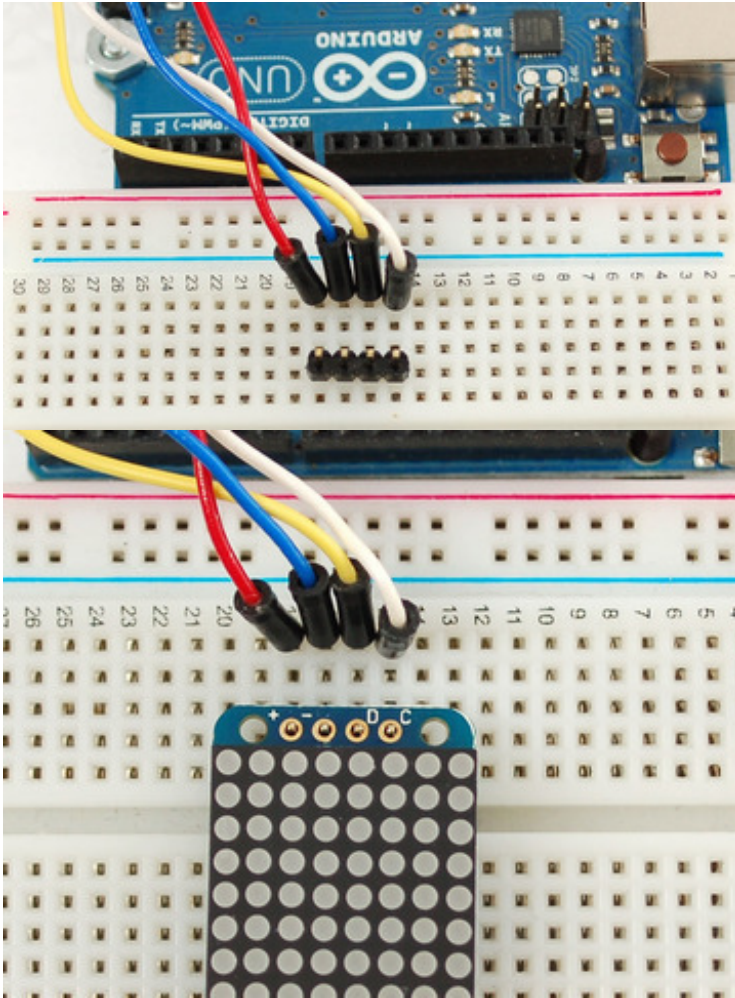

you want to use a 4pin header. You can also of course solder wires directly. Place a 4-pin piece of header with the LONG pins down into the breadboard.

Place the soldered backpack on top of the header.

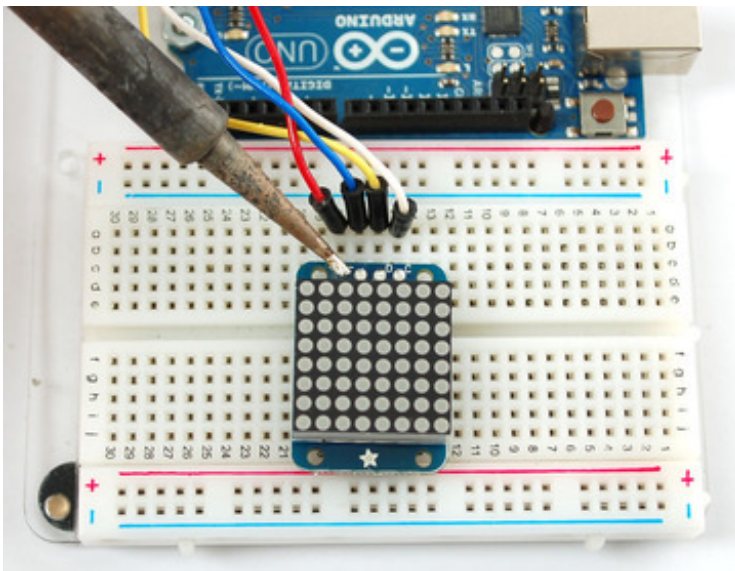

Solder 'em!



That's it! now you're ready to run the firmware!

## Mini 8x8 Matrix Software

We wrote a basic library to help you work with the mini 8x8 matrix backpack. The library is written for the Arduino and will work with any Arduino as it just uses the I2C pins. The code is very portable and can be easily adapted to any I2C-capable micro.

Wiring to the matrix is really easy

- Connect **CLK** to the I2C clock - on Arduino UNO that's Analog #5, on the Leonardo it's Digital #3, on the Mega it's digital #21
- Connect **DAT** to the I2C data - on Arduino UNO that's Analog #4, on the Leonardo it's Digital #2, on the Mega it's digital #20
- Connect **GND** to common ground
- Connect **VCC+** to power - 5V is best but 3V also seems to work for 3V microcontrollers.

Next, [download the Adafruit LED Backpack library from github \(http://adafru.it/aLI\)](http://adafru.it/aLI) . To download click the DOWNLOADS button in the top right corner, rename the uncompressed folder **Adafruit\_LEDBackpack**. Check that the **Adafruit\_LEDBackpack** folder contains **Adafruit\_LEDBackpack.cpp** and **Adafruit\_LEDBackpack.h** Place the **Adafruit\_LEDBackpack** library folder your *arduinofolder/libraries/* folder. You may need to create the *libraries* subfolder if it's your first library.

[You'll also need to download the Adafruit GFX library \(http://adafru.it/aJa\)](http://adafru.it/aJa) that provides the graphics drawing routines. Follow the same instructions as above, but with Adafruit\_GFX instead of Adafruit\_LEDBackpack.

Restart the IDE.

Once you've restarted you should be able to select the **File->Examples->Adafruit\_LEDBackpack->matrix88** example sketch. Upload it to your Arduino as usual. You should see a basic test program that goes through a bunch of different drawing routines

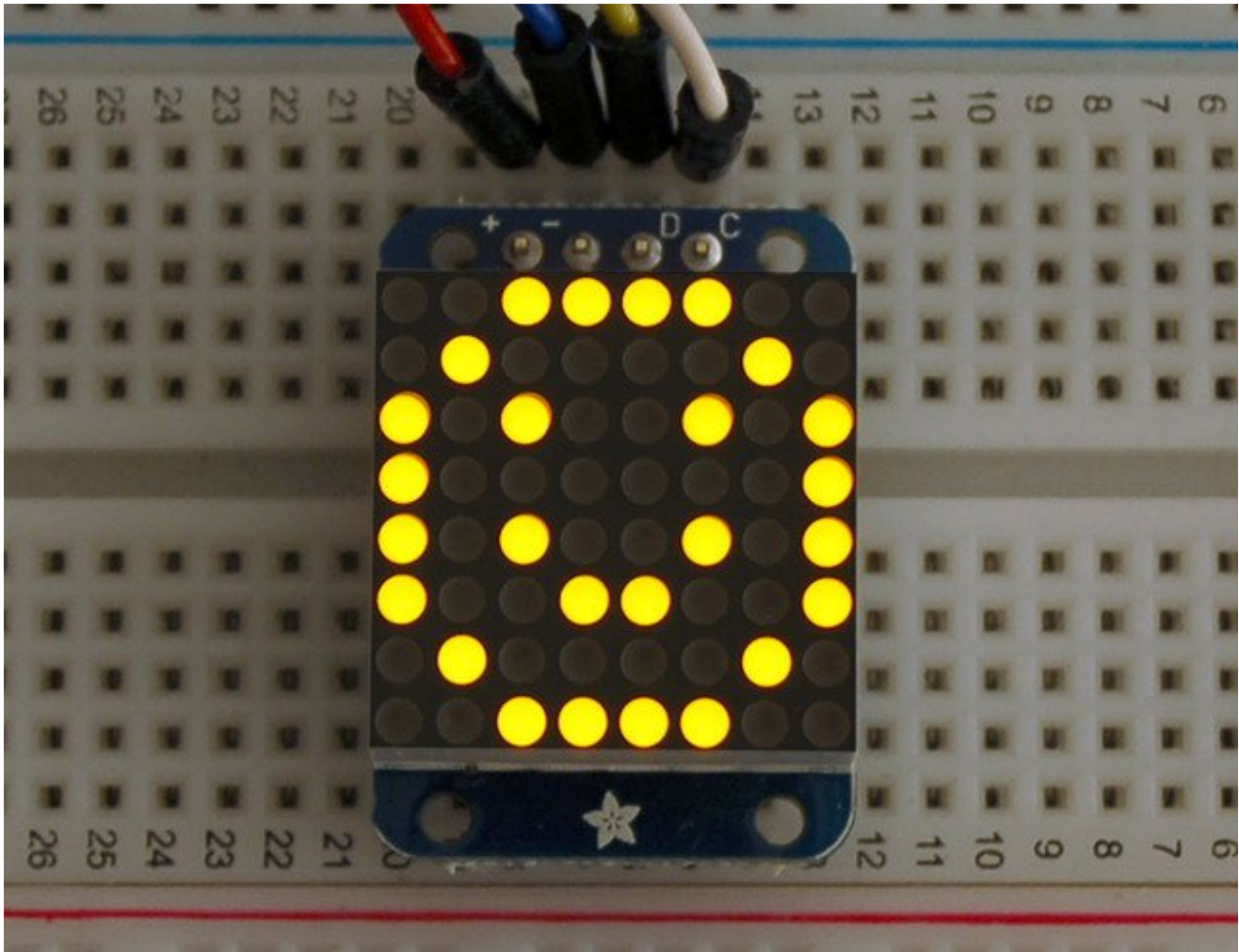

Once you're happy that the matrix works, you can write your own sketches. The 8x8 matrix supports everything the Adafruit GFX library - drawing pixels, lines, rectangles, circles, triangles, roundrects, and small bitmaps. [For more details check out the GFX page which will detail all of the GFX routines \(http://adafru.it/aPx\).](http://adafru.it/aPx)

All the drawing routines only change the display memory kept by the Arduino. Don't forget to call **writeDisplay()** after drawing to 'save' the memory out to the matrix via I2C.

There are also a few small routines that are special to the matrix:

- **setBrightness(*brightness*)**- will let you change the overall brightness of the entire display. 0 is least bright, 15 is brightest and is what is initialized by the display when you start
- **blinkRate(*rate*)** - You can blink the entire display. 0 is no blinking. 1, 2 or 3 is for display blinking.

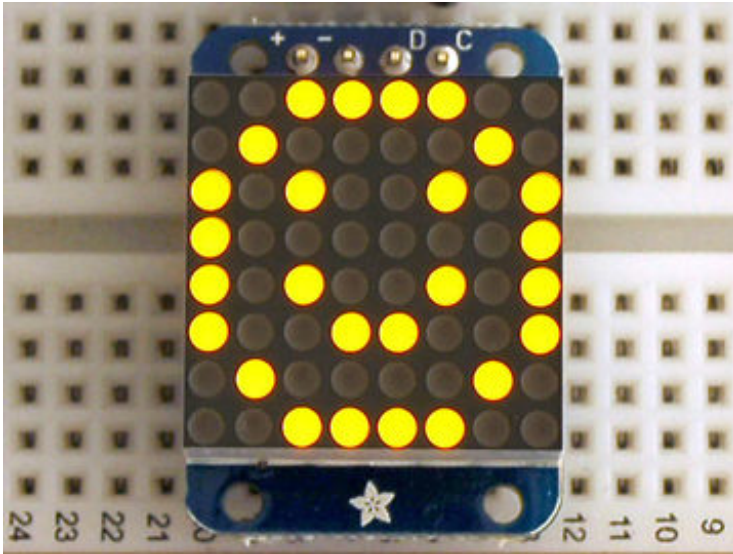

The default orientation for graphics commands on this display places pixel (0,0) at the top-left when the header is at the top and Adafruit logo at the bottom. `matrix.setRotation()` can be used to use the display in other orientations.

# 0.54" Alphanumeric

(<http://adafru.it/l3c>)

This version of the LED backpack is designed for two dual 14-segment "Alphanumeric" displays. These 14-segment displays normally require 18 pins (4 'characters' and 14 total segments each) This backpack solves the annoyance of using 18 pins or a bunch of chips by having an I2C constant-current matrix controller sit neatly on the back of the PCB. The controller chip takes care of everything, drawing all the LEDs in the background. All you have to do is write data to it using the 2-pin I2C interface.

There are three address select pins so you can select one of 8 addresses to control up to 8 of these on a single 2-pin I2C bus (as well as whatever other I2C chips or sensors you like). The driver chip can 'dim' the entire display from 1/16 brightness up to full brightness in 1/16th steps. It cannot dim individual LEDs, only the entire display at once.

## Attaching the Backpack

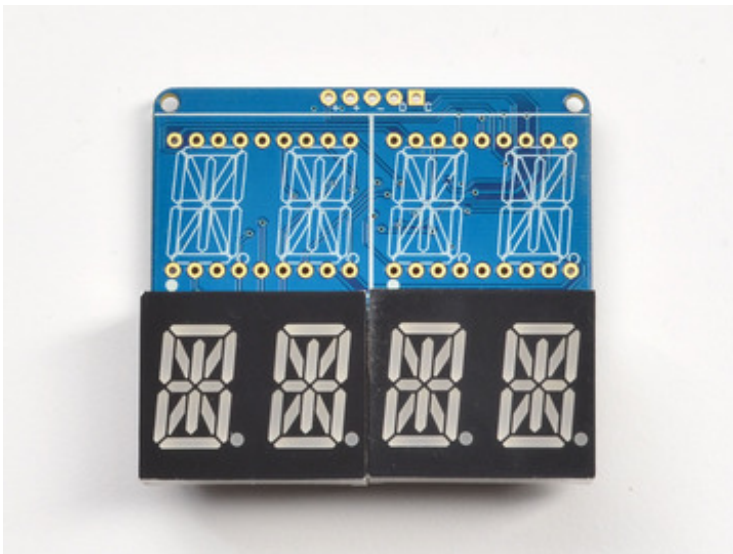

When you buy a pack from Adafruit, it comes with the fully tested and assembled backpack as well as two dual 14-segment display in one of the colors we provide (say, red, yellow, blue or green). You'll need to solder the matrix onto the backpack but it's an easy task.

Remove the parts from packaging and place the LED matrices **OVER** the silkscreen side. **DO NOT PUT THE DISPLAY ON UPSIDE DOWN**

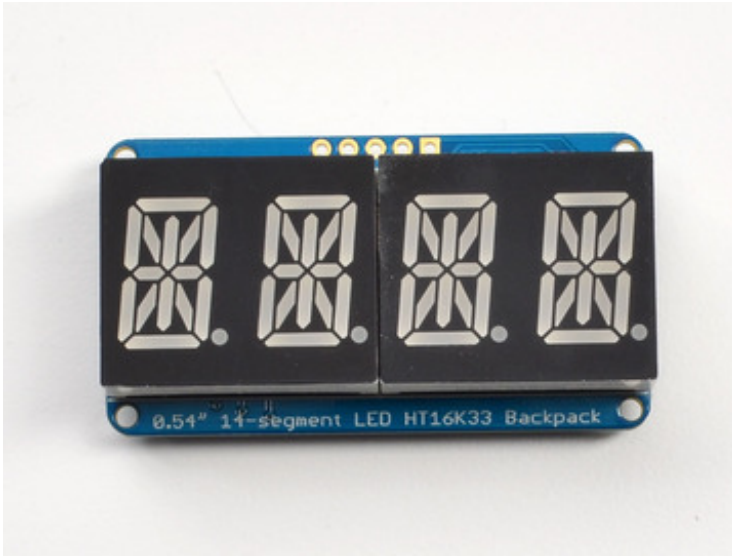

**OR IT WONT WORK!! Check the image below to make sure the 'decimal point' dots are on the bottom, matching the silkscreen.**

Remove the parts from packaging and place the LED matrices OVER the silkscreen side. **DO NOT PUT THE DISPLAY ON UPSIDE DOWN OR IT WONT WORK!!** Check the image below to make sure the 'decimal point' dots are on the bottom, matching the silkscreen.

**DO NOT PUT THE DISPLAY ON UPSIDE DOWN OR IT WONT WORK!!** Check the image below to make sure the 'decimal point' dots are on the bottom, matching the silkscreen. Remove the parts from packaging and place the LED matrices OVER the silkscreen side. **DO NOT PUT THE DISPLAY ON UPSIDE DOWN OR IT WONT WORK!!**

Remove the parts from packaging and place the LED matrices OVER the silkscreen side. **DO NOT PUT THE DISPLAY ON UPSIDE DOWN OR IT WONT WORK!!** Check the image below to make sure the 'decimal point' dots are on the bottom, matching the silkscreen.

**DO NOT PUT THE DISPLAY ON UPSIDE DOWN OR IT WONT WORK!!** Check the image below to make sure the 'decimal point' dots are on the bottom, matching the silkscreen. Remove the parts from packaging and place the LED matrices OVER the silkscreen side. **DO NOT PUT THE DISPLAY ON UPSIDE DOWN OR IT WONT WORK!!**

Remove the parts from packaging and place the LED matrices OVER the silkscreen side. **DO NOT PUT THE DISPLAY ON UPSIDE DOWN OR IT WONT WORK!!** Check the image below to make sure the 'decimal point' dots are on the bottom, matching the silkscreen.

**DO NOT PUT THE DISPLAY ON UPSIDE DOWN OR IT WONT WORK!!** Check the image below to make sure the 'decimal point' dots are on the bottom, matching the silkscreen. Remove the parts from packaging and place the LED matrices OVER the silkscreen side. **DO NOT PUT THE DISPLAY ON UPSIDE DOWN OR IT WONT WORK!!** Check the image below to make sure the 'decimal point' dots are on the bottom, matching the silkscreen.



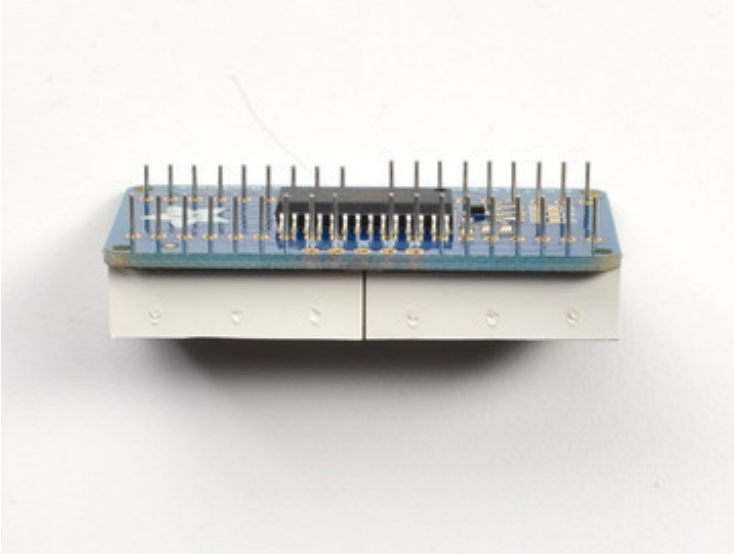

Turn the backpack over so it is sitting flat on the matrix.

•

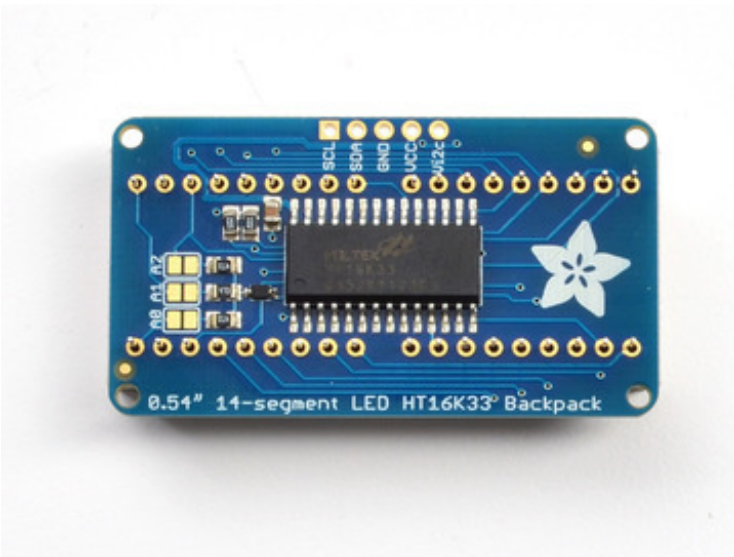

•

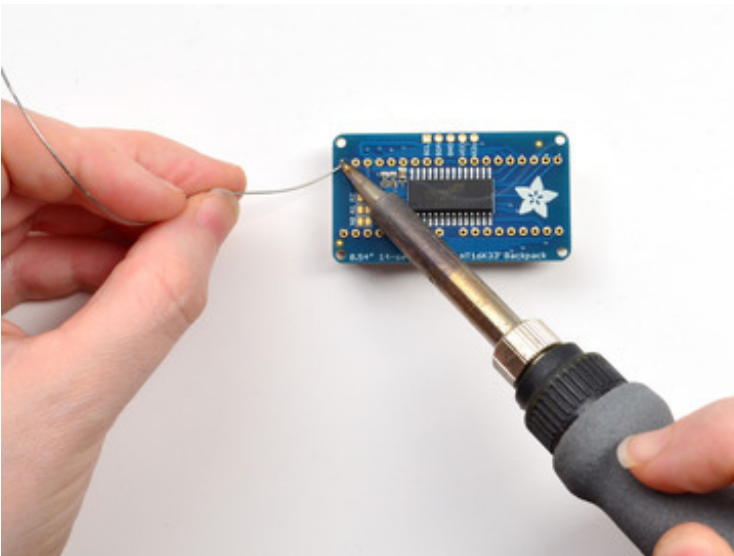

•

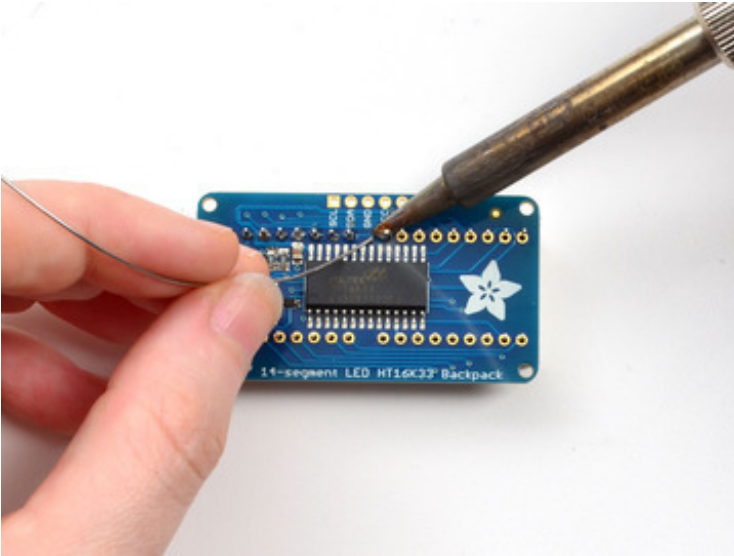

•

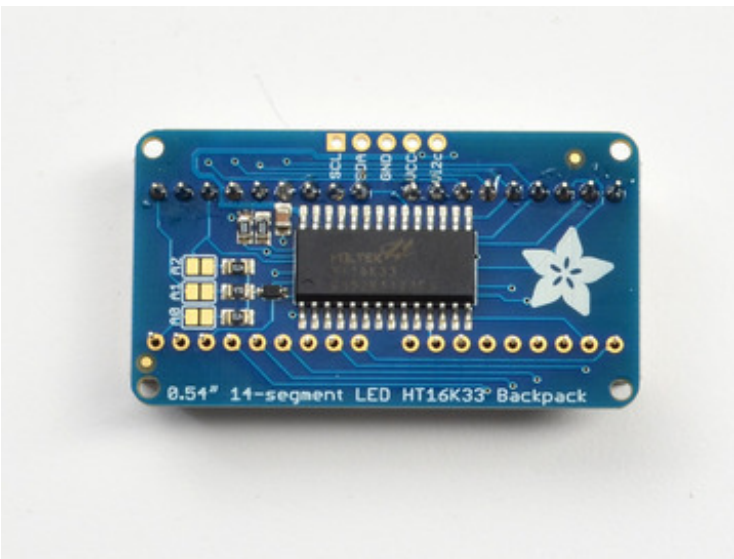

•

Solder all of the pins!

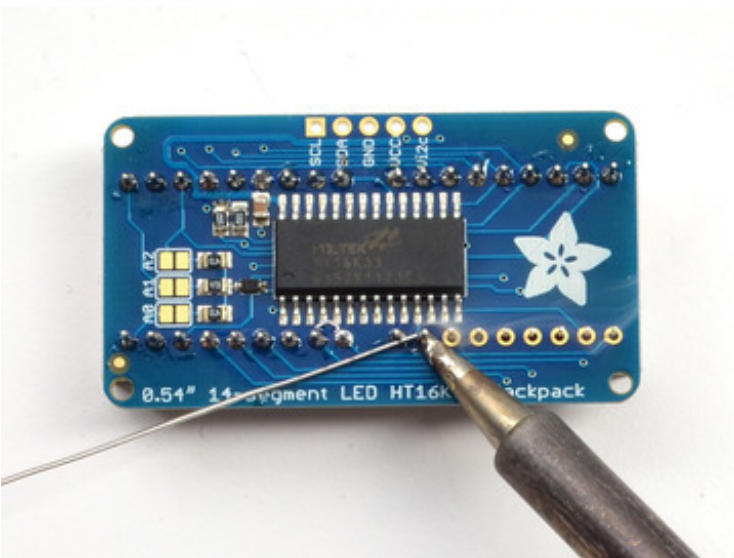

•

Clip the long pins.

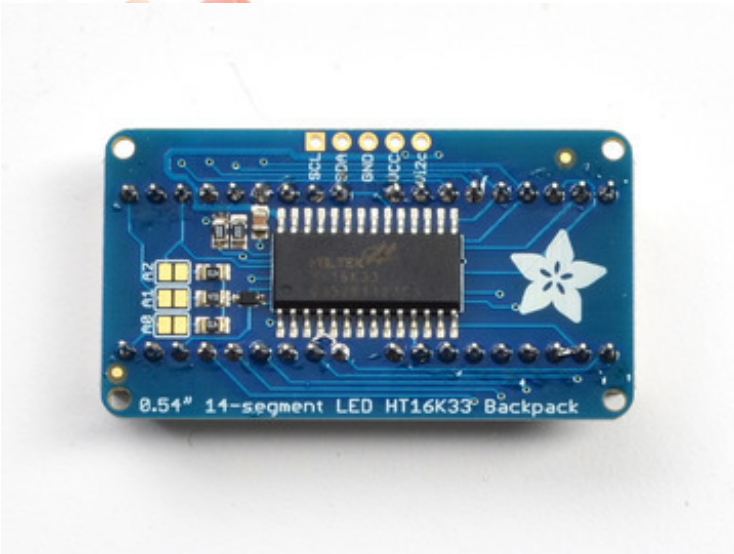

Check your work, making sure each pin is nicely soldered, and there's no cold solder joints or shorted pins

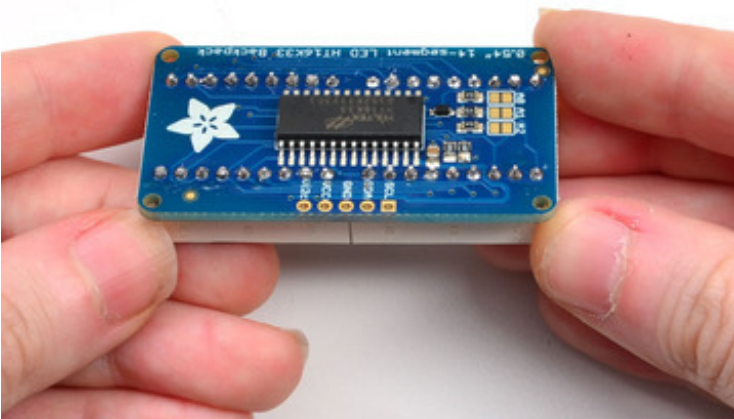

## Attaching Header

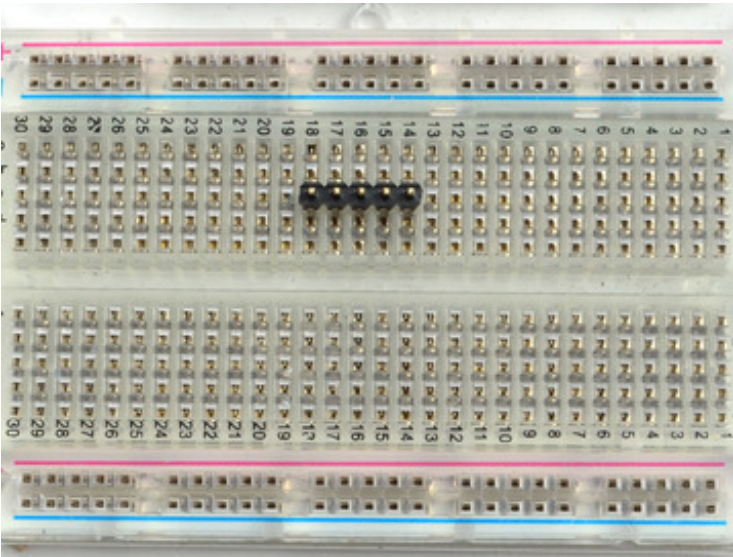

## Prepare the header strip:

Cut the strip to length if necessary. It will be easier to solder if you insert it into a breadboard - **long pins down**

•

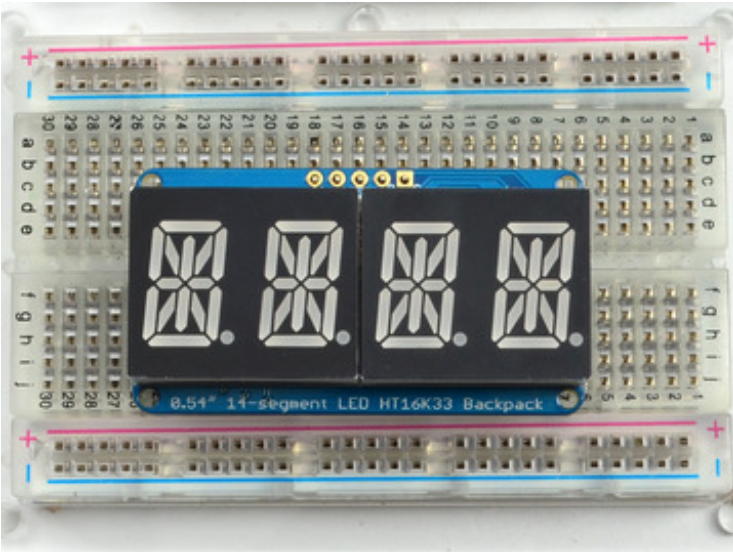

## Add the Backpack:

Place the backpack board over the pins so that the short pins poke through the breakout pads

•



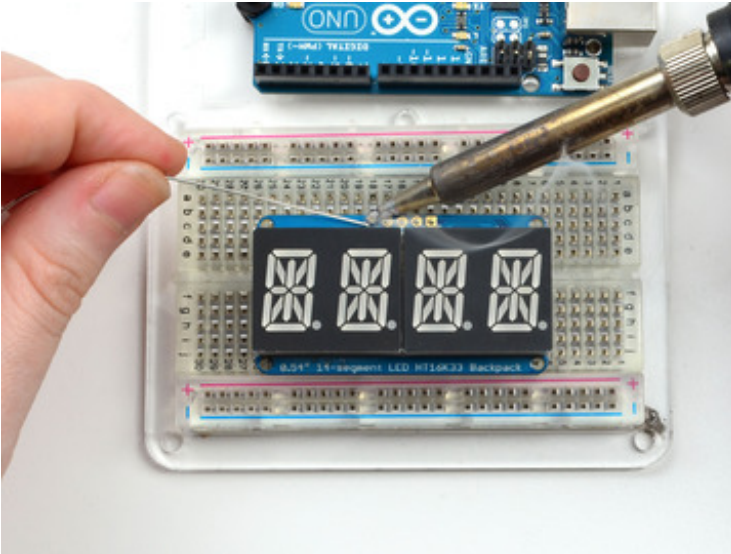

Solder all 5 pins!

That's it! now you're ready to run the firmware on your Arduino!

## Downloading the Arduino Library

We wrote a basic library to help you work with the alphanumeric backpack. The library is written for the Arduino and will work with any Arduino as it just uses the I2C pins. The code is very portable and can be easily adapted to any I2C-capable micro.

Begin by downloading our [Adafruit LED Backpack library from github](http://adafru.it/aLI) (<http://adafru.it/aLI>). You can do that by visiting the github repo and manually downloading or, easier, just click this button to download the zip

[Download LED Backpack Library](#)

<http://adafru.it/dxh>

Rename the uncompressed folder **Adafruit\_LEDBackpack** and check that the **Adafruit\_LEDBackpack** folder contains **Adafruit\_LEDBackpack.cpp** and **Adafruit\_LEDBackpack.h**

Place the **Adafruit\_LEDBackpack** library folder your **arduinofolder/libraries/** folder.

You may need to create the **libraries** subfolder if its your first library. Restart the IDE.

We also have a great tutorial on Arduino library installation at:

<http://learn.adafruit.com/adafruit-all-about-arduino-libraries-install-use> (<http://adafru.it/aYM>)

You'll also need to download the Adafruit GFX library - even though this particular backpack doesn't use it! Its just one of those Arduino dependencies! You can grab the [Adafruit GFX library from github](http://adafru.it/aJa) (<http://adafru.it/aJa>) or download by clicking below.

[Download Adafruit GFX Library](#)

<http://adafru.it/cBB>

Rename the uncompressed folder **Adafruit\_GFX** and check that the **Adafruit\_GFX** folder contains **Adafruit\_GFX.cpp** and **Adafruit\_GFX.h**

Place the **Adafruit\_GFX** library folder your **arduinofolder/libraries/** folder like you did with the LED backpacks

## Wiring!

Next up, let's wire it up to an Arduino. We'll be using an Arduino.

- Connect **CLK** to the I2C clock - on Arduino UNO that's Analog #5, on the Leonardo it's Digital #3, on the Mega it's digital #21
- Connect **DAT** to the I2C data - on Arduino UNO that's Analog #4, on the Leonardo it's Digital #2, on the Mega it's digital #20
- Connect **GND** to common ground
- Connect **VCC+** to power - 5V is best but 3V will work if that's all you've got (it will be dimmer)
- Connect **Vi2c** to your microcontroller's logic level (3-5V) - If you're using an Arduino, this is almost certainly 5V. If it's a 3V Arduino such as a Due, connect it to 3V

Both **Vi2c** and **Vcc** MUST be connected to 3 to 5VDC! Vcc is for the LED driver power, Vi2c is what sets the logic level for communication to the chip.

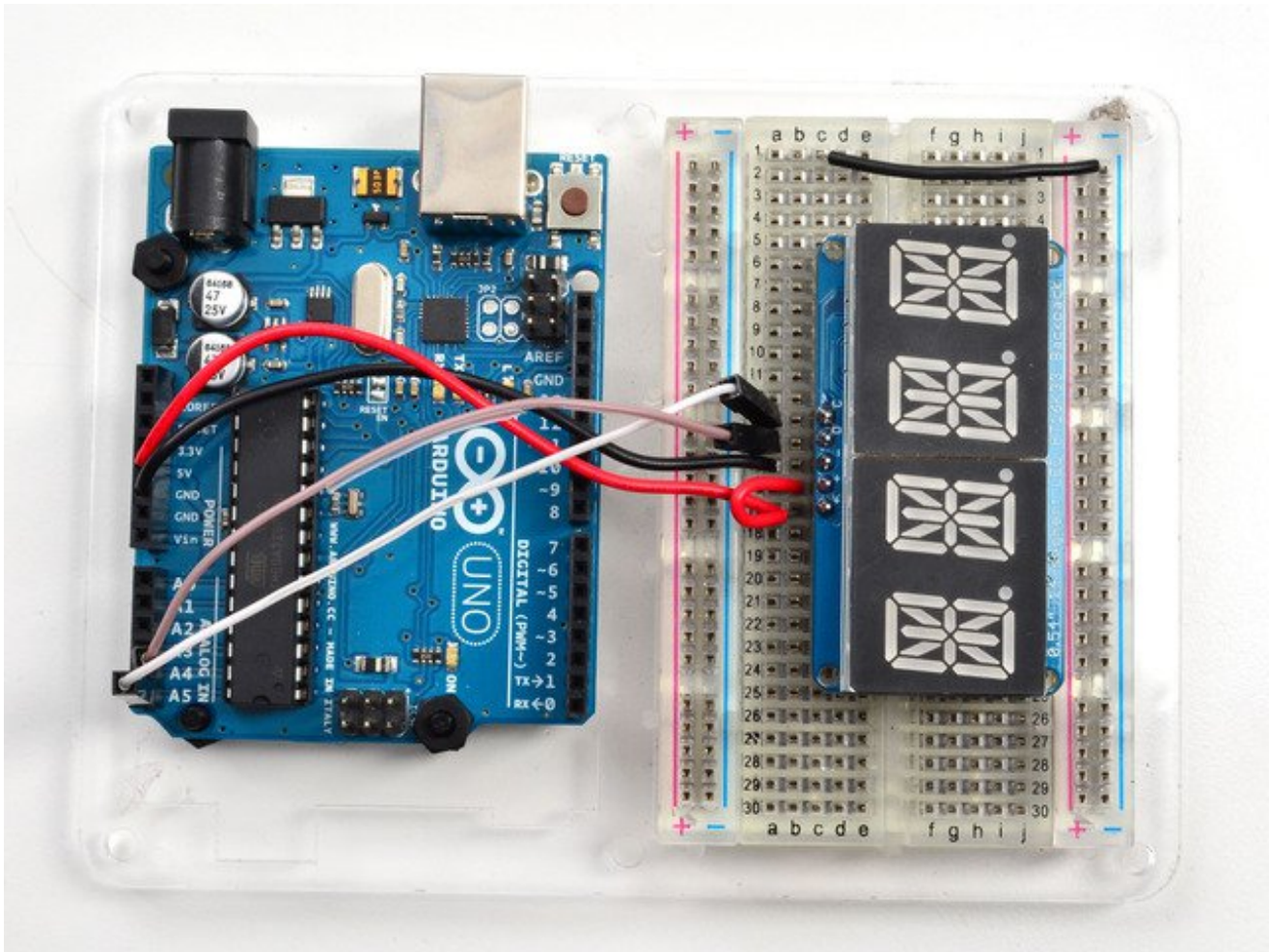

## Load Demo

Restart the Arduino IDE and load up the **File->Adafruit\_LEDBackpack->quadalphanum** demo

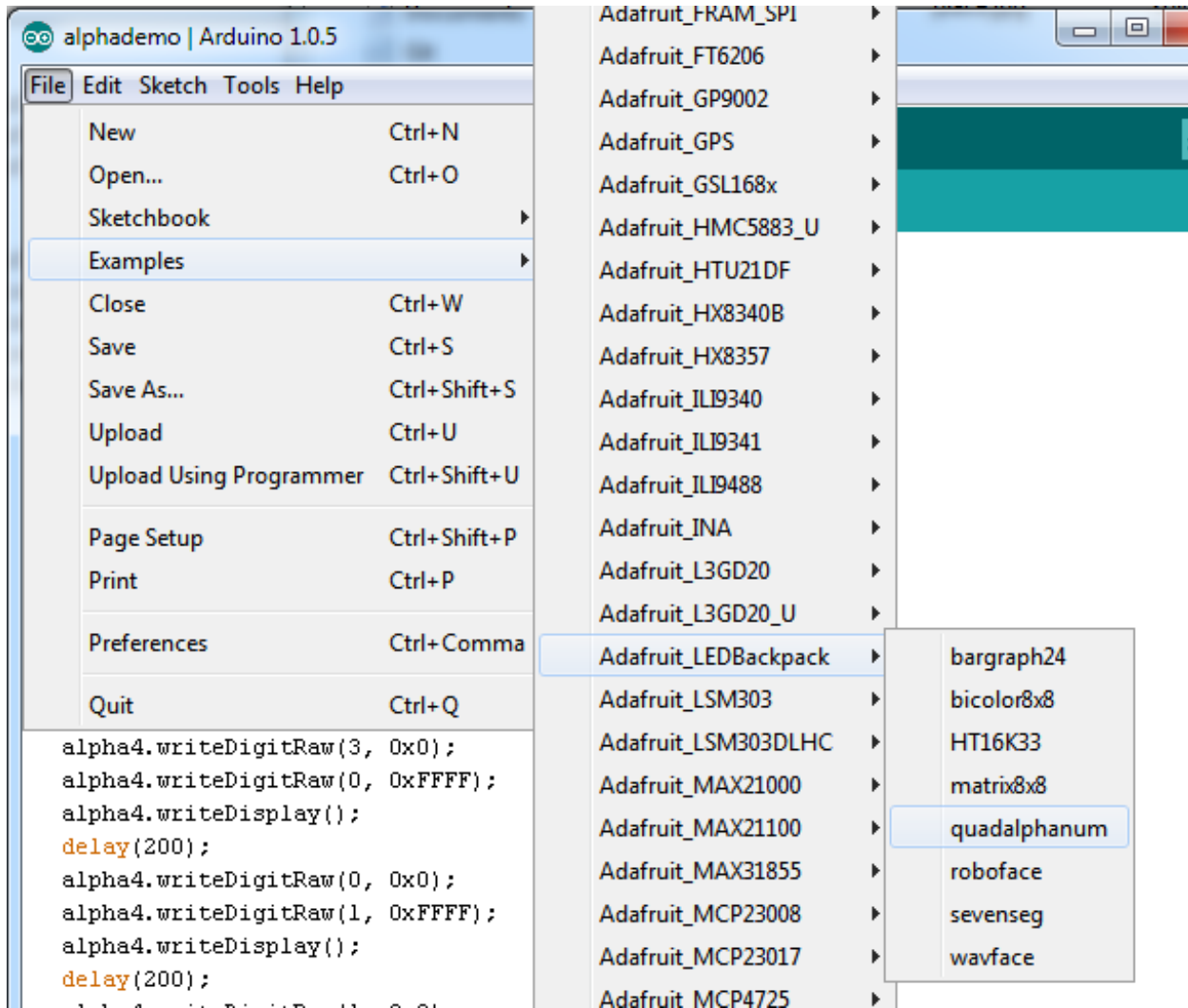

Upload to your Arduino, and open up the Serial console at 9600 baud speed. You'll see each digit light up all the segments, then the display will scroll through the 'font table' showing every character that it knows how to display. Finally, you'll get a notice to start typing into the serial console. Type a message and hit return, you'll see it scroll onto the display!



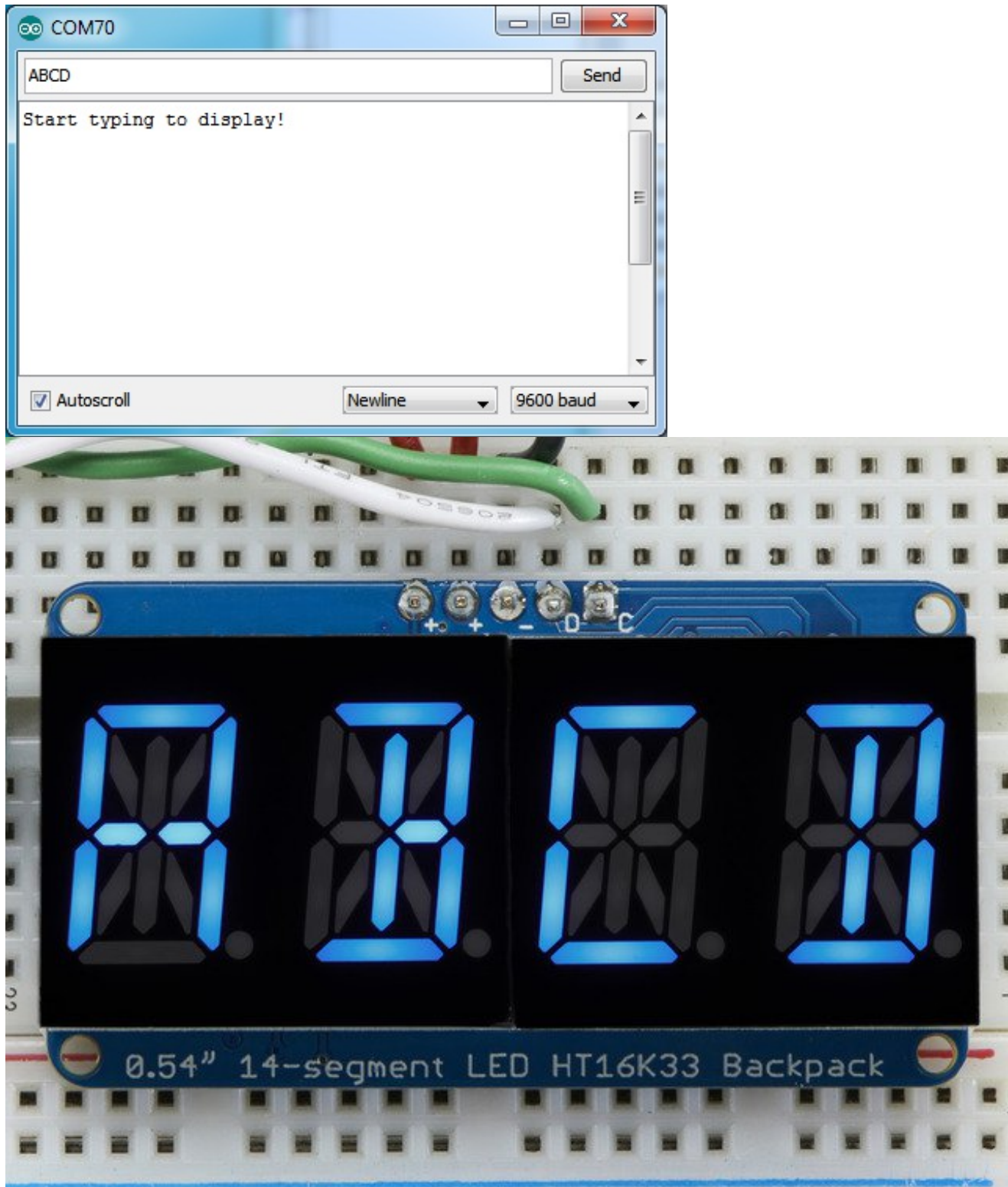

## Library Reference

For the quad displays, we have a special object that can handle ascii data for easy printing.



You can create the object with

```
Adafruit_AlphaNum4 alpha4 = Adafruit_AlphaNum4();
```

There's no arguments or pins because the backpacks use the fixed I2C pins. By default, the address is 0x70, but you can pass in the I2C address used when you initialize the display with **begin**

```
alpha4.begin(0x70); // pass in the address
```

Next up, the segments can be turned on/off for each digit by writing the 'raw' bitmap you want, for example, all the LEDs off on digit #3 is

```
alpha4.writeDigitRaw(3, 0x0);
```

All the segments on for digit #0 is

```
alpha4.writeDigitRaw(0, 0x3FFF);
```

This is the segment map:

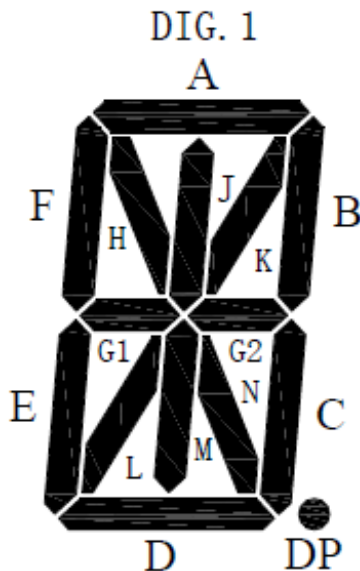

the 16 bit digit you pass in for raw image has this mapping

0 DP N M L K J H G2 G1 F E D C B A

The first bit isn't used, you can make it 0 or 1

To turn on just the **A** segment, use 0x0001

To turn on just the **G1** segment, use 0x0040

## ASCII data

If you're just looking to print 'text' you can use our font table, just pass in an ASCII character!

For example, to set digit #0 to **A** call:

```
alpha4.writeDigitAscii(0, 'A')
```

## Writing Data

Don't forget to 'write' the data to the display with

```
alpha4.writeDisplay();
```

That's what actually 'sets' the data onto the LEDs!

# 0.56" 7-Segment Backpack

This version of the LED backpack is designed for these big bright 7-segment displays. These 7-segment displays normally require 13 pins (5 'characters' and 8 total segments each) This backpack solves the annoyance of using 13 pins or a bunch of chips by having an I2C constant-current matrix controller sit neatly on the back of the PCB. The controller chip takes care of everything, drawing all the LEDs in the background. All you have to do is write data to it using the 2-pin I2C interface. There are three address select pins so you can select one of 8 addresses to control up to 8 of these on a single 2-pin I2C bus (as well as whatever other I2C chips or sensors you like). The driver chip can 'dim' the entire display from 1/16 brightness up to full brightness in 1/16th steps. It cannot dim individual LEDs, only the entire display at once.

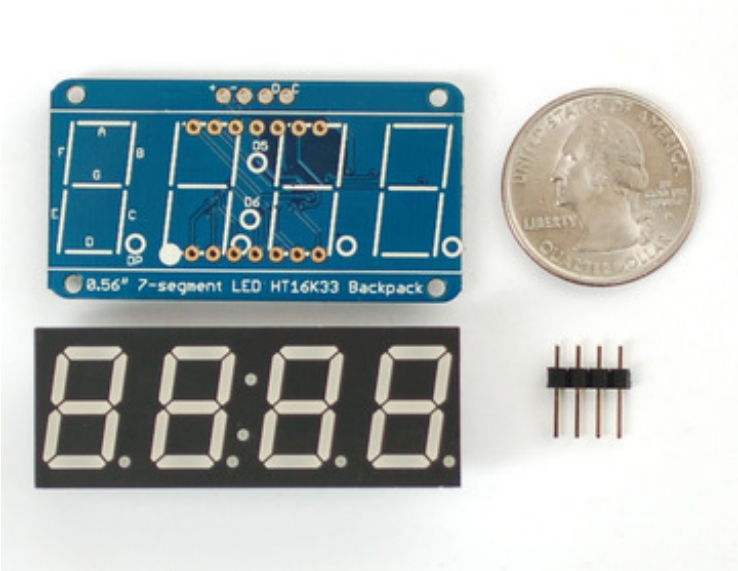

When you buy a pack from Adafruit, it comes with the fully tested and assembled backpack as well as a 7-segment display in one of the colors we provide (say, red, yellow, blue or green). You'll need to solder the matrix onto the backpack but it's an easy task.

- 

Remove the parts from packaging and place the LED matrix OVER the silkscreen



side. **DO NOT PUT THE DISPLAY ON UPSIDE DOWN OR IT WONT WORK!!** Check the image below to make sure the 'decimal point' dots are on the bottom, matching the silkscreen.

•

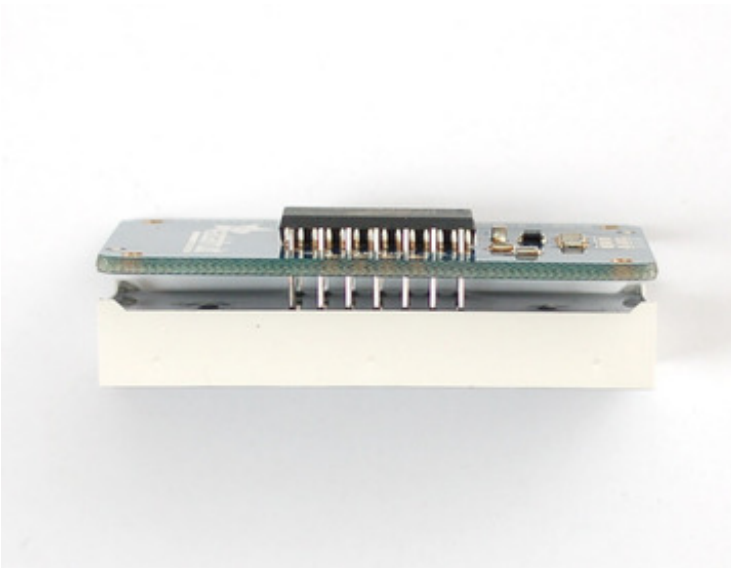

Turn the backpack over so it is sitting flat on the matrix.

•

Solder all 14 pins.

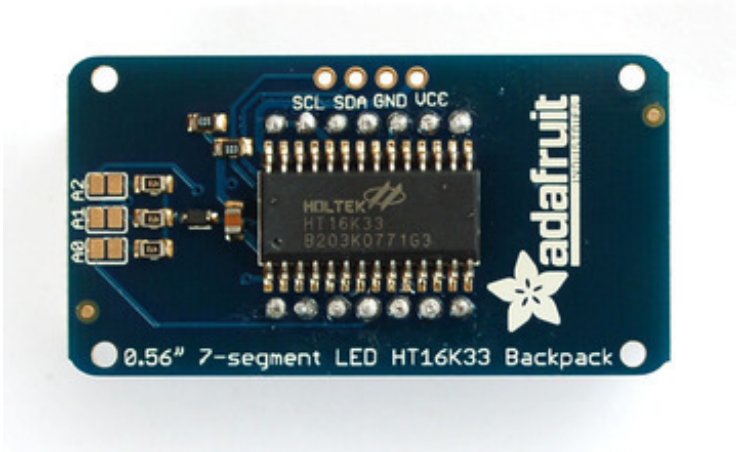
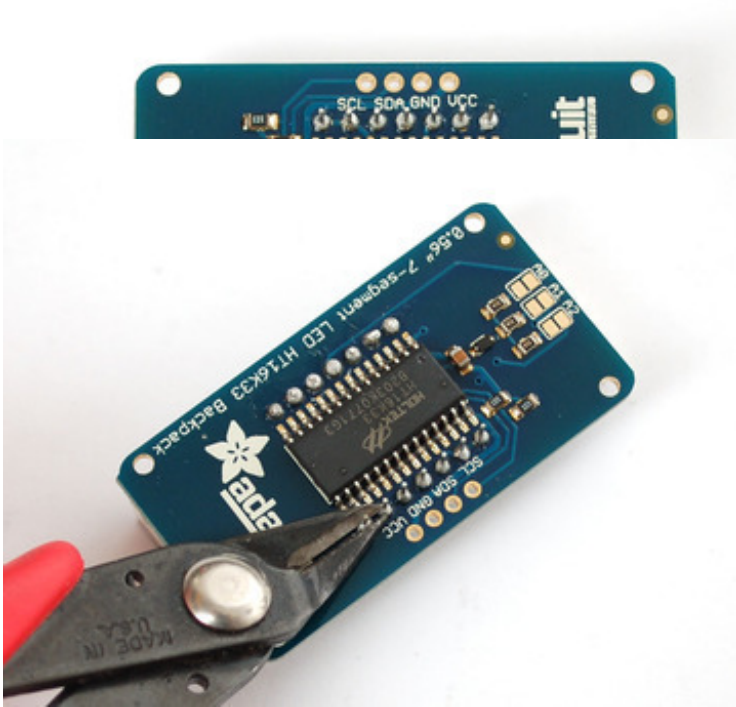

Clip the long pins.



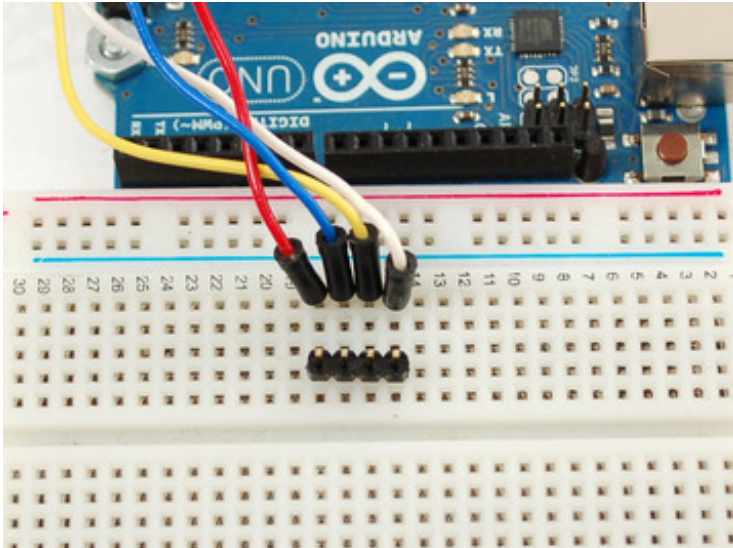

Now you're ready to wire it up to a microcontroller. We'll assume you want to use a 4pin header. You can also of course solder wires directly. Place a 4-pin piece of header with the LONG pins down into the breadboard.

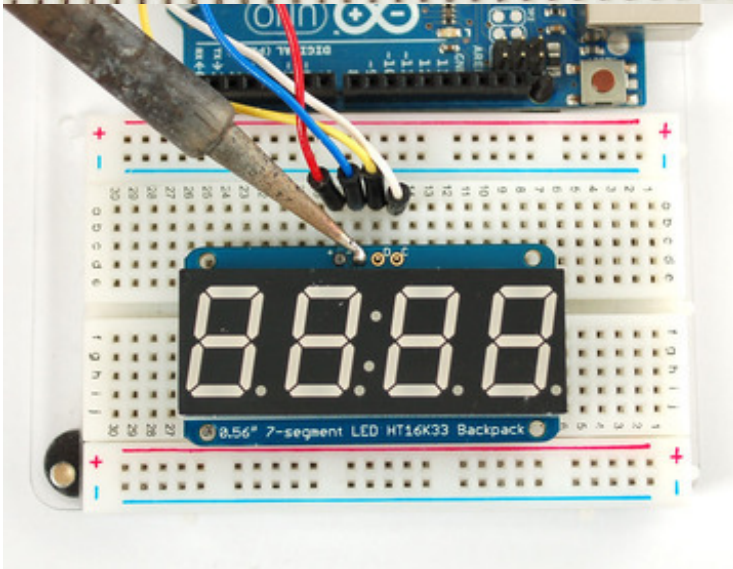

Place the soldered backpack on top of the header and Solder 'em!

That's it! now you're ready to run the firmware!

## Seven-Segment Backpack Firmware

We wrote a basic library to help you work with the 7-segment backpack. The library is written for the Arduino and will work with any Arduino as it just uses the I2C pins. The code is very portable and can be easily adapted to any I2C-capable micro.

Wiring to the matrix is really easy

- Connect **CLK** to the I2C clock - on Arduino UNO that's Analog #5, on the Leonardo it's Digital #3, on the Mega it's digital #21
- Connect **DAT** to the I2C data - on Arduino UNO that's Analog #4, on the Leonardo it's Digital #2, on the Mega it's digital #20
- Connect **GND** to common ground
- Connect **VCC+** to power - 5V is best but 3V also seems to work for 3V microcontrollers.

Next, [download the Adafruit LED Backpack library from github \(http://adafru.it/aLI\)](http://adafru.it/aLI) . To download click the DOWNLOADS button in the top right corner, rename the uncompressed folder **Adafruit\_LEDBackpack**. Check that the **Adafruit\_LEDBackpack** folder contains **Adafruit\_LEDBackpack.cpp** and **Adafruit\_LEDBackpack.h** Place the **Adafruit\_LEDBackpack** library folder your *arduinodesketchfolder/libraries/* folder. You may need to create the *libraries* subfolder if it's your first library. [You'll also need to download the Adafruit GFX library \(http://adafru.it/aJa\)](http://adafru.it/aJa) - rename it **Adafruit\_GFX** and install it as the LED backpack library. It's not actually used for the 7-segment, it's only for the matrix backpacks but it's still required. Restart the IDE.

Once you've restarted you should be able to select the **File?Examples?Adafruit\_LEDBackpack?sevensseg** example sketch. Upload it to your Arduino as usual. You should see a basic test program that goes through a bunch of different routines.

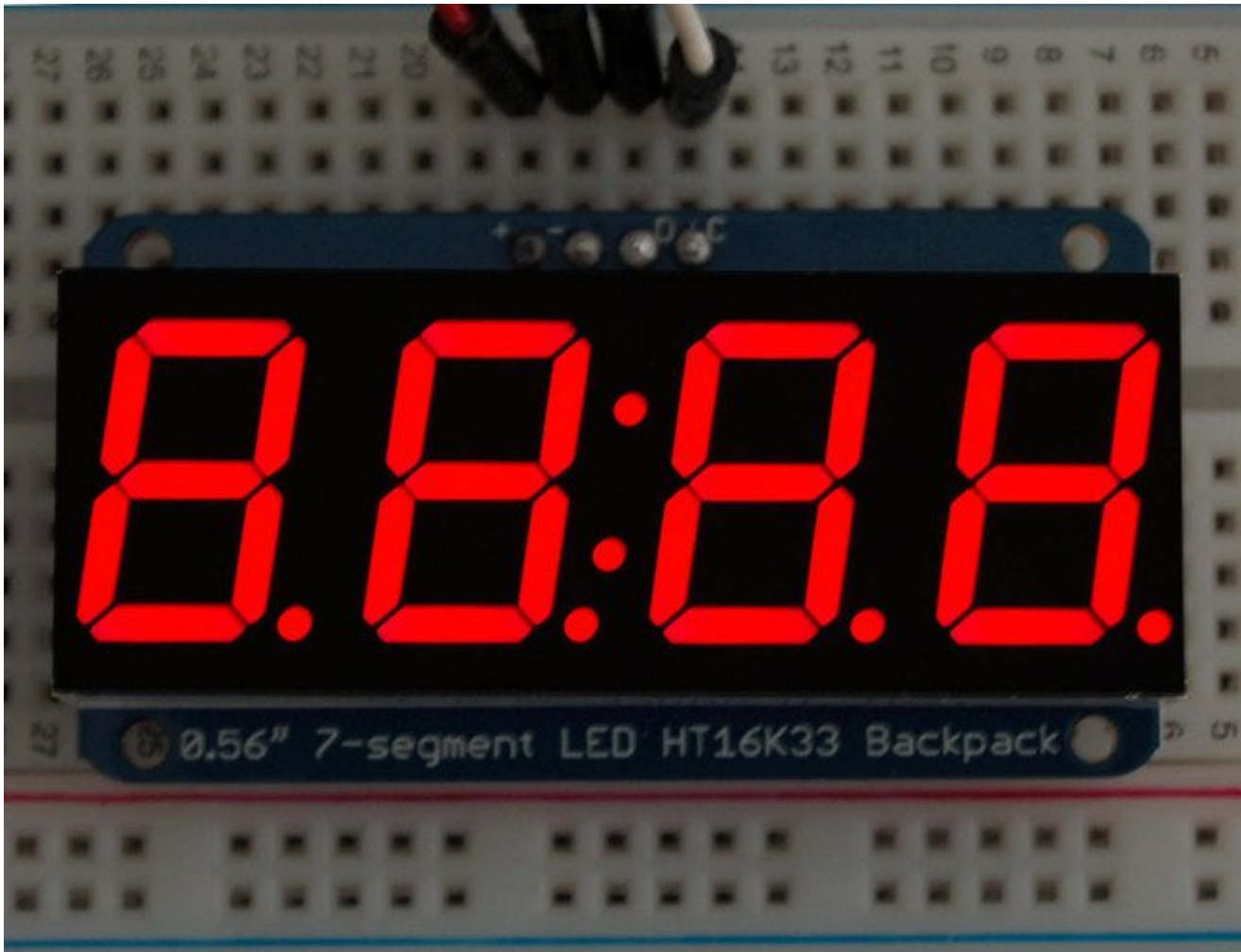

Once you're happy that the matrix works, you can write your own sketches.

There's a few ways you can draw to the display. The easiest is to just call **print** - just like you do with **Serial**

- **print(variable,HEX)** - this will print a hexadecimal number, from 0000 up to FFFF
- **print(variable,DEC)** or **print(variable)** - this will print a decimal integer, from 0000 up to 9999

If you need more control, you can call **writeDigitNum(location, number)** - this will write the *number* (0-9) to a single location. Location #0 is all the way to the left, location #2 is the colon dots so you probably want to skip it, location #4 is all the way to the right. If you want a decimal point, call **writeDigitNum(location, number, true)** which will paint the decimal point. To draw the colon, use **drawColon(true or false)**

If you want even more control, you can call **writeDigitRaw(location, bitmask)** to draw a raw 8-bit mask (as stored in a `uint8_t`) to that location.

All the drawing routines only change the display memory kept by the Arduino. Don't forget

to call **writeDisplay()** after drawing to 'save' the memory out to the matrix via I2C.

There are also a few small routines that are special to the backpack:

- **setBrightness(*brightness*)**- will let you change the overall brightness of the entire display. 0 is least bright, 15 is brightest and is what is initialized by the display when you start
- **blinkRate(*rate*)** - You can blink the entire display. 0 is no blinking. 1, 2 or 3 is for display blinking.

# 1.2" 7-segment Backpack

These backpacks drive the massive 1.2" 7-segment modules. With 2 leds per segment these make a gorgeous and impressive display. The 7-segment displays normally require 16 pins to drive. This backpack uses an I2C constant-current matrix controller on the back of the PCB, so you only need 2 pins to drive it!

The controller chip takes care of multiplexing all the LEDs in the background. All you have to do is write data to it using the 2-pin I2C interface. There are three address select pins so you can select one of 8 addresses to control up to 8 of these on a single 2-pin I2C bus (as well as whatever other I2C chips or sensors you like). The driver chip can 'dim' the entire display from 1/16 brightness up to full brightness in 1/16th steps. It cannot dim individual LEDs, only the entire display at once.



When you buy a pack from Adafruit, it comes with the fully tested and assembled backpack as well as a 7-segment display in one of the colors we provide (say, red, yellow, blue or green). You'll need to solder the matrix onto the backpack but its an easy task.



Remove the parts from packaging and place the LED matrix **OVER** the silkscreen side. **DO NOT PUT THE DISPLAY ON UPSIDE DOWN OR IT WONT WORK!!** Check the image below to make sure the 'decimal point' dots are in the same location as the ones on the silkscreen.



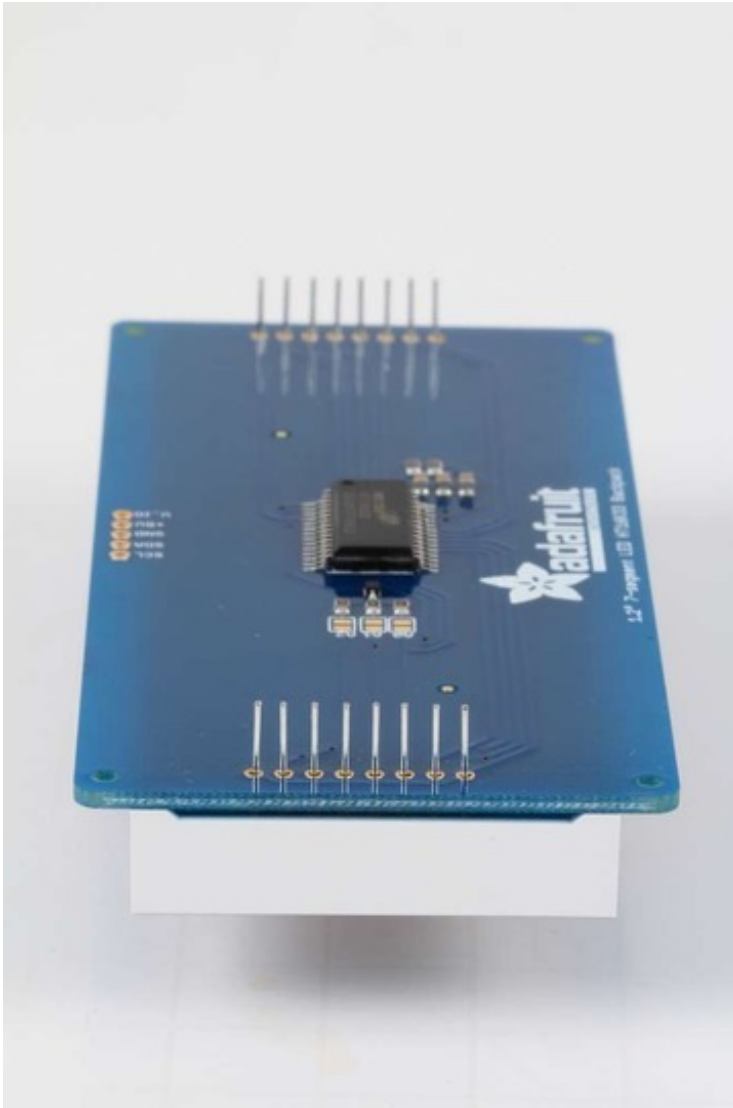

Turn the backpack over so its sitting flat on the matrix and ready to solder.

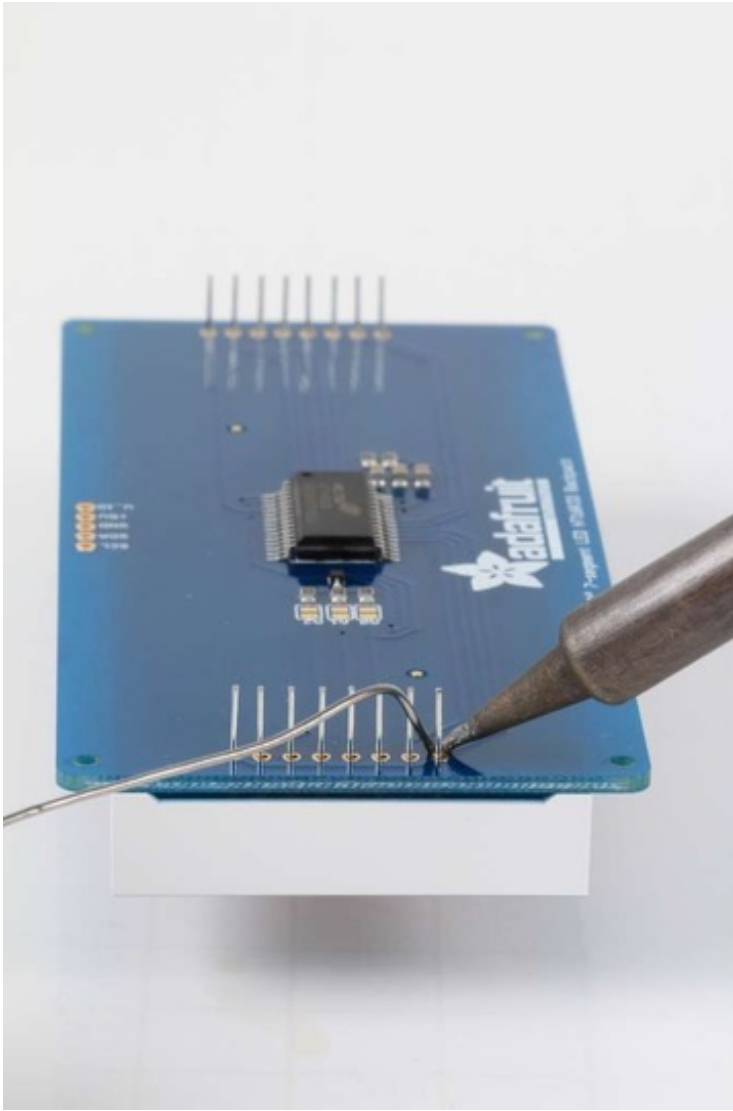

Then solder each pin. There are 8 on each end for a total of 16.

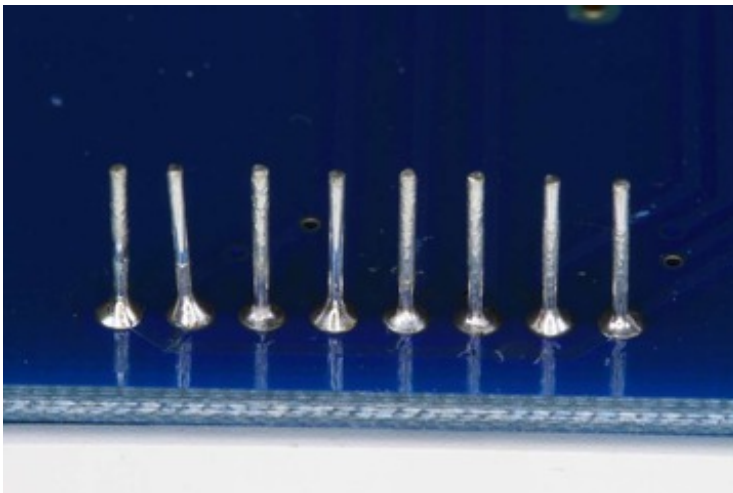

That completes the basic assembly. For use on a breadboard, you will want to also install a 5-pin header on the edge of the board.

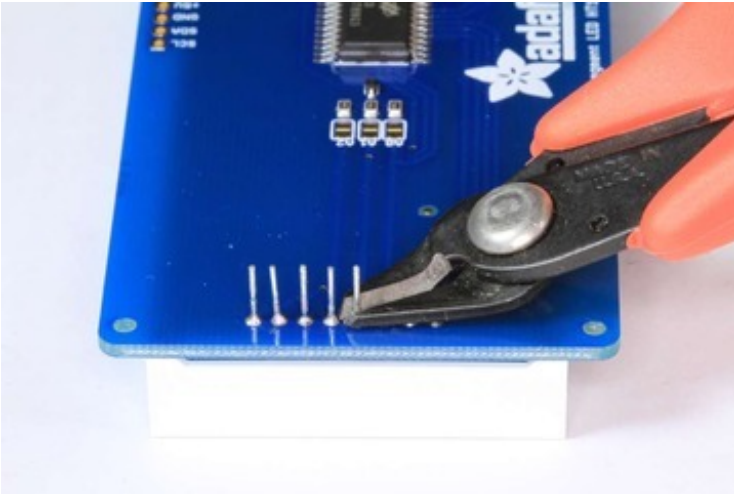

Clip the long pins close to the board.

•



Cut the header strip to length if necessary and insert LONG pins down into the breadboard.

•



•

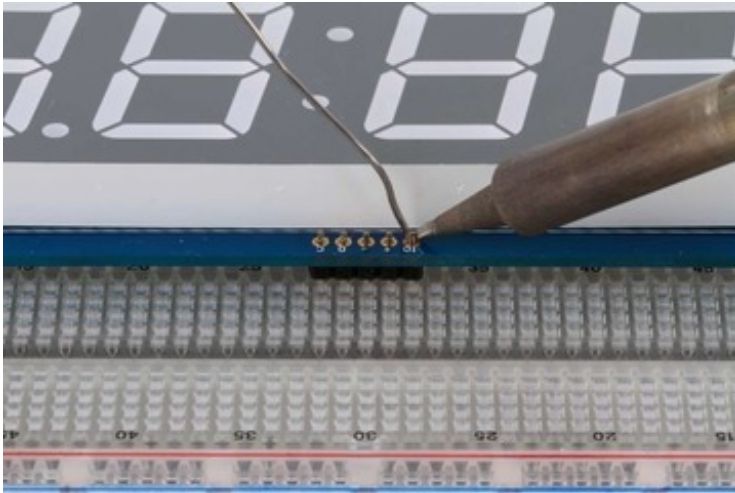

Then solder all 5 pins.



Now you are ready to wire it to your microcontroller. The required connections are:

- **"D"** - I2C Data Pin (SDA)
- **"C"** - I2C Clock Pin (SCL)
- **"+"** - 5v. (Will not run on 3.3v!)
- **"-"** - GND
- **"IO"** - I2C bus voltage.

Due to the size of this display, there are 2 LEDs in series for each segment. Because of this, the display requires 5v to run. It will not run on 3.3v.

For use with 3.3v processors, connect the IO pin to 3.3v. This will keep the I2C bus signals at a safe level for your processor.

With 5v processors like the Arduino UNO, this pin can be connected to either 5v or 3.3v. (use 3.3v if there will be other 3.3v devices on the bus)



## Arduino Wiring - R3 and later

### Connect:

- D -> SDA
- C -> SCL
- + -> 5v
- - -> GND
- IO -> jumper to + for 5v.

•

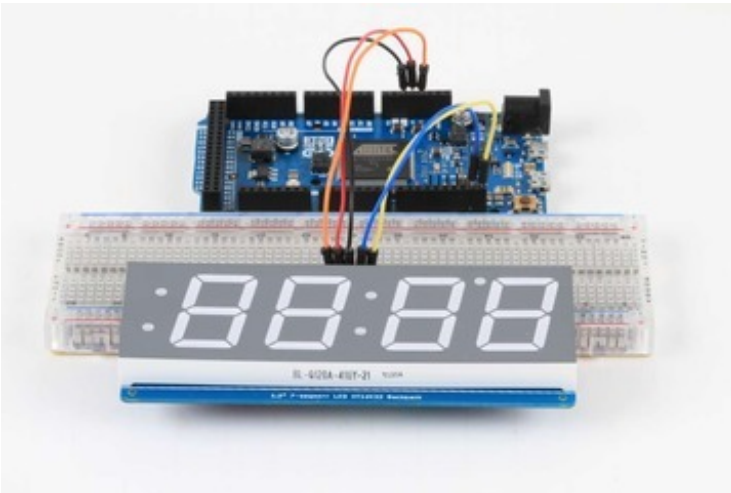

## Arduino Due and Other 3.3v Processors

### Connect:

- D -> SDA
- C -> SCL
- + -> 5v
- - -> GND
- IO -> 3.3v

•

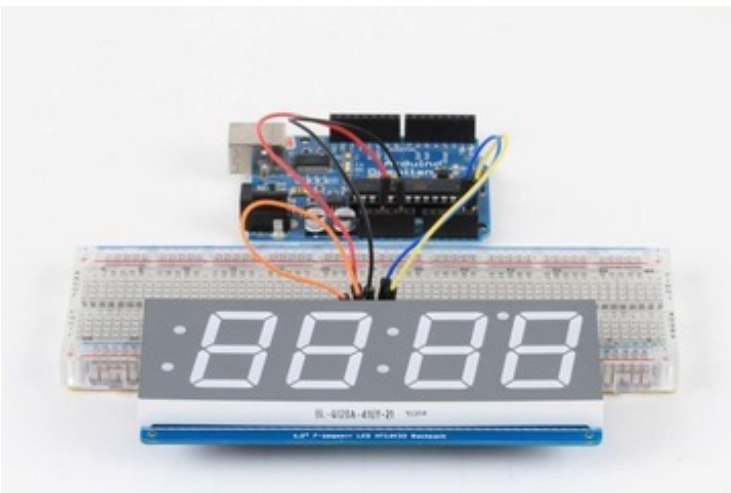

## Arduino "Classic" Wiring

### Connect:

- D -> Analog-4 or Digital 20 for the Mega
- C -> Analog-5 or Digital 21 for the Mega
- + -> 5v
- - -> GND
- IO -> jumper to + for 5v.

•



OK, now on to the firmware!

## Seven-Segment Backpack Firmware

Our 7-segment backpack library makes it easy to program these displays. The library is written for the Arduino and will work with any Arduino as it just uses the I2C pins. The code is very portable and can be easily adapted to any I2C-capable micro.

You can [download the Adafruit LED Backpack library from github \(http://adafru.it/aLI\)](http://adafru.it/aLI) . To download click the DOWNLOADS button in the top right corner, rename the uncompressed folder **Adafruit\_LEDBackpack**. Check that the **Adafruit\_LEDBackpack** folder contains **Adafruit\_LEDBackpack.cpp** and **Adafruit\_LEDBackpack.h**.

If you need help with installing you libraries, we have a detailed guide here:

[Installing Arduino Libraries](http://adafru.it/aYM)

<http://adafru.it/aYM>

[You'll also need to download the Adafruit GFX library \(http://adafru.it/aJa\)](http://adafru.it/aJa) - rename it **Adafruit\_GFX** and install it as the LED backpack library. Close all open IDE windows and restart the IDE.

Once you've restarted you should be able to select the **File?Examples?Adafruit\_LEDBackpack?sevensseg** example sketch. Upload it to your Arduino as usual. You should see a "sevensseg" example sketch that will demonstrate various capabilities of the library and the display.



Once you're happy that the matrix works, you can write your own sketches.

There's a few ways you can draw to the display. The easiest is to just call **print** - just like you do with **Serial**

- **print(variable,HEX)** - this will print a hexadecimal number, from 0000 up to FFFF
- **print(variable,DEC)** or **print(variable)** - this will print a decimal integer, from 0000 up to 9999

If you need more control, you can call **writeDigitNum(location, number)** - this will write the *number* (0-9) to a single location. Location #0 is all the way to the left, location #2 is the colon dots so you probably want to skip it, location #4 is all the way to the right.

To control the colon and decimal points, use the **writeDigitRaw(location, bitmap)** function. (Note that both dots of the center colon are wired together internal to the display, so it is not possible to address them separately.) Specify 2 for the location and the bits are mapped as follows:

- 0x02 - center colon (both dots)
- 0x04 - left colon - lower dot
- 0x08 - left colon - upper dot
- 0x10 - decimal point

If you want a decimal point, call **writeDigitNum(*location*, *number*, *true*)** which will paint the decimal point. To draw the colon, use **drawColon(*true* or *false*)**

If you want full control of the segments in all digits, you can call **writeDigitRaw(*location*,*bitmask*)** to draw a raw 8-bit mask (as stored in a uint8\_t) to any location.

All the drawing routines only change the display memory kept by the Arduino. Don't forget to call **writeDisplay()** after drawing to 'save' the memory out to the matrix via I2C.

There are also a few small routines that are special to the backpack:

- **setBrightness(*brighness*)**- will let you change the overall brightness of the entire display. 0 is least bright, 15 is brightest and is what is initialized by the display when you start
- **blinkRate(*rate*)** - You can blink the entire display. 0 is no blinking. 1, 2 or 3 is for display blinking.

# Bi-Color 8x8 Matrix

This version of the LED backpack is designed for these bright and colorful square-pixelated 8x8 matrices. They have 64 red and 64 green LEDs inside, for a total of 128 LEDs controlled as a 8x16 matrix. This backpack solves the annoyance of using 24 pins or a bunch of chips by having an I2C constant-current matrix controller sit neatly on the back of the PCB. The controller chip takes care of everything, drawing all 128 LEDs in the background. All you have to do is write data to it using the 2-pin I2C interface. There are three address select pins so you can select one of 8 addresses to control up to 8 of these on a single 2-pin I2C bus (as well as whatever other I2C chips or sensors you like). The driver chip can 'dim' the entire display from 1/16 brightness up to full brightness in 1/16th steps. It cannot dim individual LEDs, only the entire display at once.

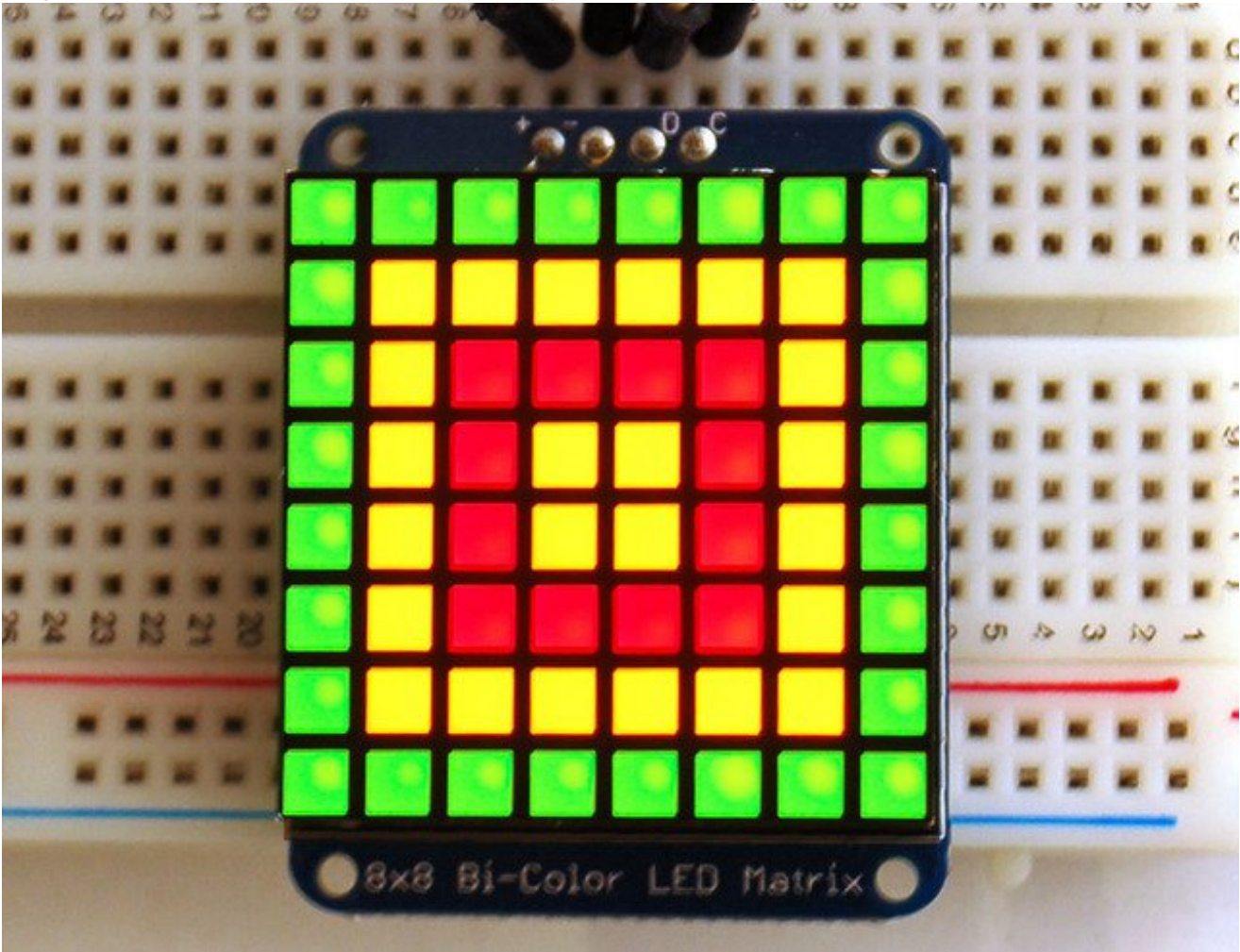

Pay close attention to the instructions for positioning the matrix. It must be oriented correctly to work and is almost impossible to remove it once it has been soldered to the backpack!

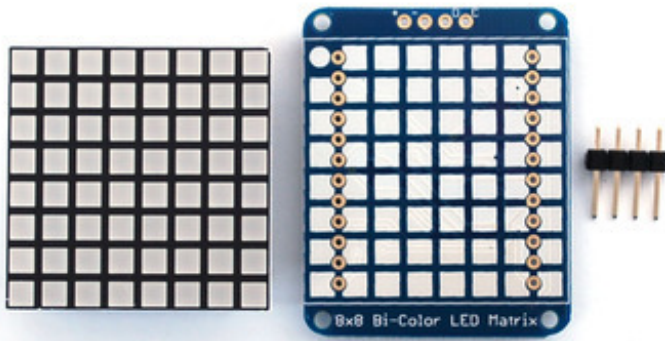

When you buy a pack from Adafruit, it comes with the fully tested and assembled backpack as well as a 8x8 matrix. You'll need to solder the matrix onto the backpack but its an easy task.

•

Remove the parts from packaging and place the LED matrix OVER the silkscreen side.



**The matrix must be soldered on the correct orientation or it will not work! Check for the side of the matrix that has printing on it. Then look for the front of the PCB that has a circle instead of a square in the corner and line those up as shown on the left**

•

Do not solder the matrix over the chip on the back of the backpack - it will not work then!





Turn the backpack over so its sitting flat on the matrix.



Solder all 24 pins.

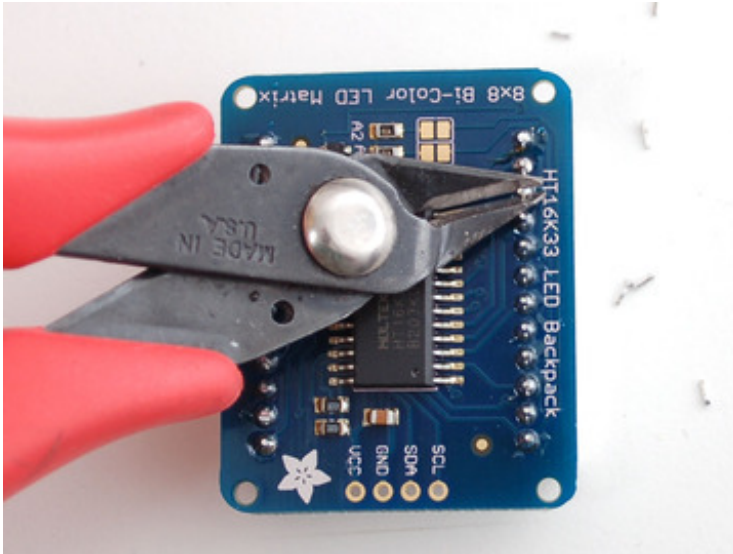

Clip the long pins



Now you're ready to wire it up to a microcontroller. We'll assume

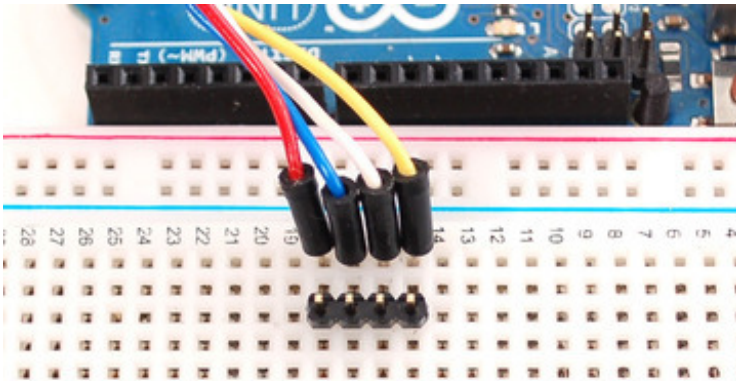

you want to use a 4pin header. You can also of course solder wires directly. Place a 4-pin piece of header with the LONG pins down into the breadboard.

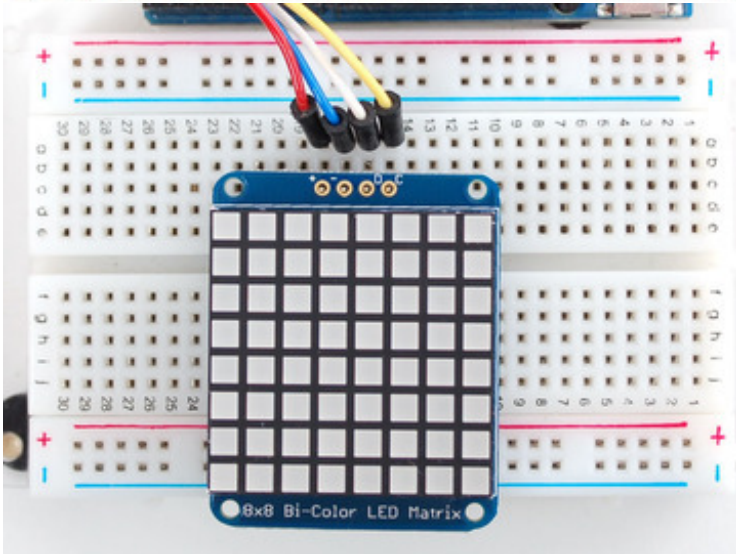

Place the soldered backpack on top of the header.

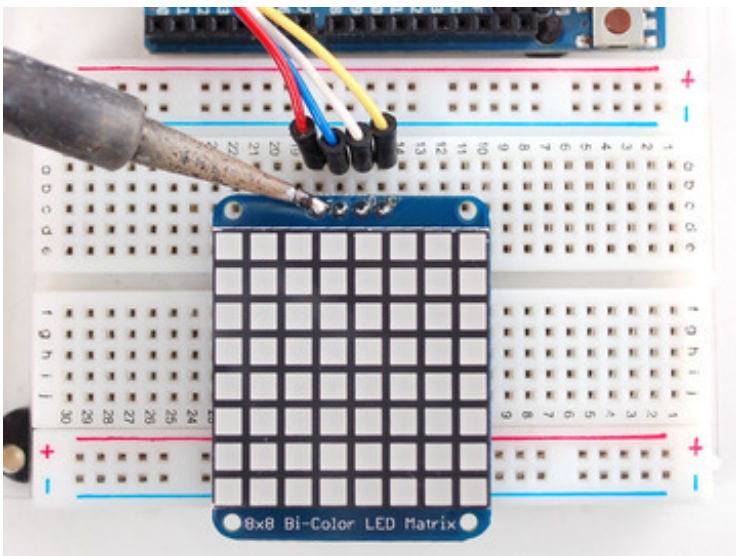

Solder 'em!

# Bi-Color 8x8 LED Backpack Firmware

We wrote a basic library to help you work with the bi-color 8x8 matrix backpack. The library is written for the Arduino and will work with any Arduino as it just uses the I2C pins. The code is very portable and can be easily adapted to any I2C-capable micro.

Wiring to the matrix is really easy

- Connect **CLK** to the I2C clock - on Arduino UNO that's Analog #5, on the Leonardo it's Digital #3, on the Mega it's digital #21
- Connect **DAT** to the I2C data - on Arduino UNO that's Analog #4, on the Leonardo it's Digital #2, on the Mega it's digital #20
- Connect **GND** to common ground
- Connect **VCC+** to power - 5V is best but 3V also seems to work for 3V microcontrollers.

Next, [download the Adafruit LED Backpack library from github \(http://adafru.it/aLI\)](http://adafru.it/aLI) . To download click the DOWNLOADS button in the top right corner, rename the uncompressed folder **Adafruit\_LEDBackpack**. Check that the **Adafruit\_LEDBackpack** folder contains **Adafruit\_LEDBackpack.cpp** and **Adafruit\_LEDBackpack.h** Place the **Adafruit\_LEDBackpack** library folder your *arduinofolder/libraries/* folder. You may need to create the *libraries* subfolder if it's your first library. [You'll also need to download the Adafruit GFX library \(http://adafru.it/aJa\)](http://adafru.it/aJa) that provides the graphics drawing routines. Restart the IDE.

Once you've restarted you should be able to select the **File->Examples->Adafruit\_LEDBackpack->bicolor88** example sketch. Upload it to your Arduino as usual. You should see a basic test program that goes through a bunch of different drawing routines



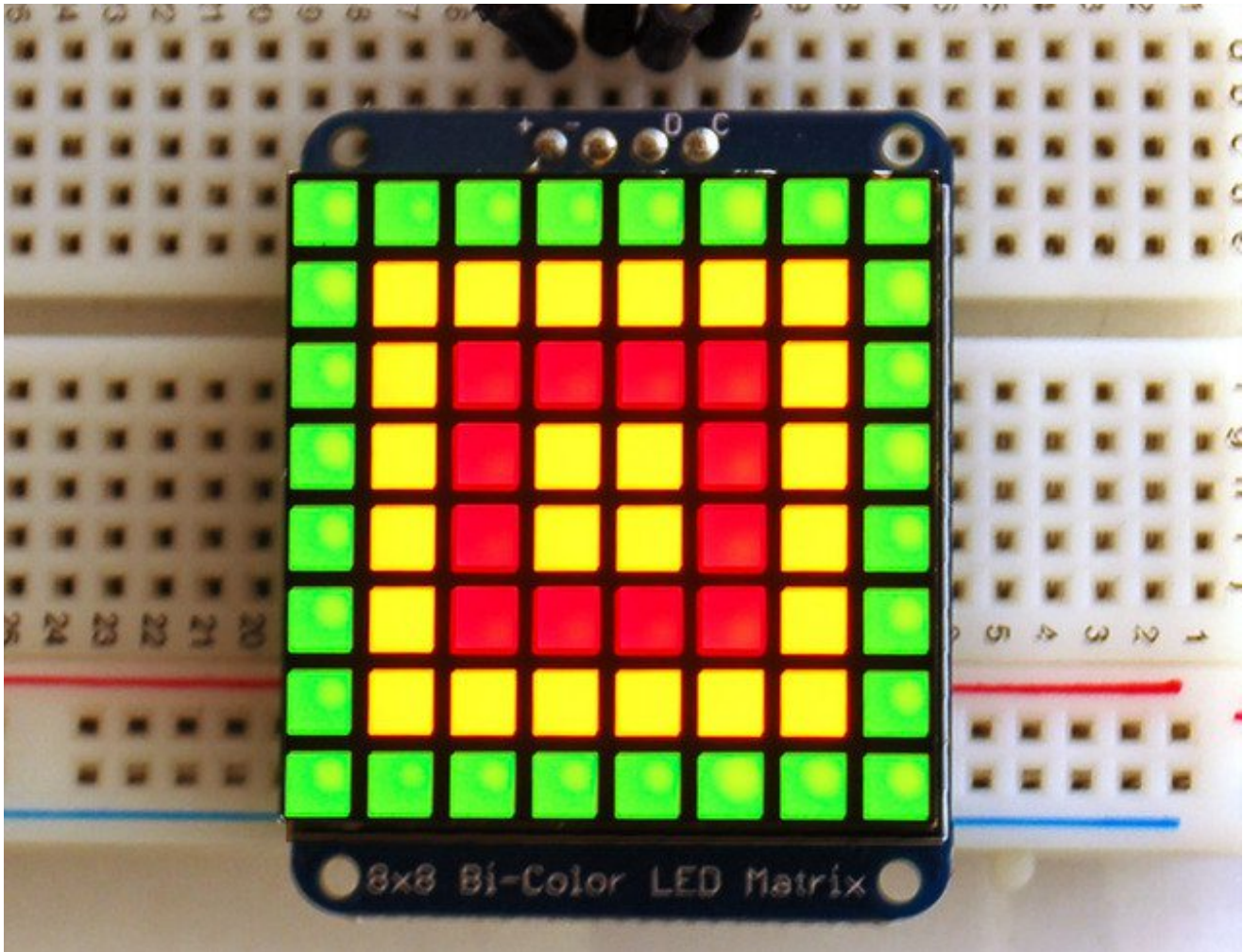

Once you're happy that the matrix works, you can write your own sketches. The 8x8 matrix supports everything the Adafruit GFX library - drawing pixels, lines, rectangles, circles, triangles, roundrects, and small bitmaps. [For more details check out the GFX page which will detail all of the GFX routines \(http://adafru.it/aPx\).](http://adafru.it/aPx)

All the drawing routines only change the display memory kept by the Arduino. Don't forget to call **writeDisplay()** after drawing to 'save' the memory out to the matrix via I2C.

There are also a few small routines that are special to the matrix:

- **setBrightness(*brightness*)**- will let you change the overall brightness of the entire display. 0 is least bright, 15 is brightest and is what is initialized by the display when you start
- **blinkRate(*rate*)** - You can blink the entire display. 0 is no blinking. 1, 2 or 3 is for display blinking.



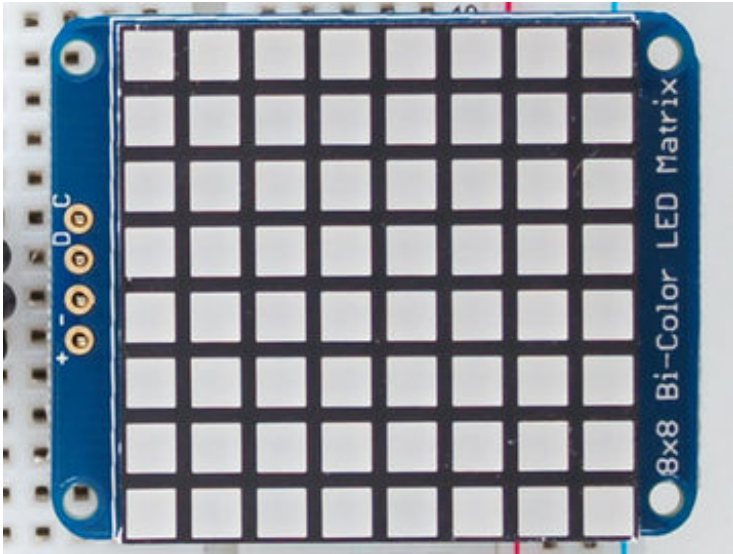

The default orientation for graphics commands on this display places pixel (0,0) at the top-left when the header is at the left and Adafruit logo at the right. To use the matrix as shown above (header at top, logo at bottom), call `matrix.setRotation(3)` before issuing graphics commands.

## Schematic

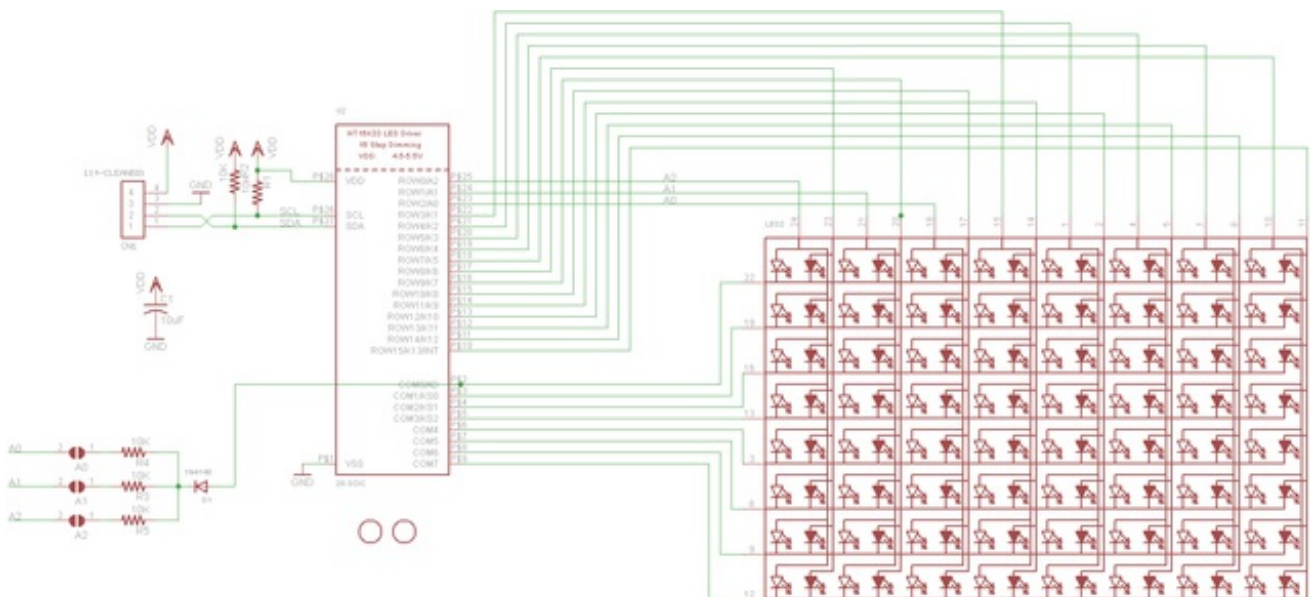



# Bi-Color 24 Bargraph

This version of the LED backpack is designed for these bright and colorful bi-color bargraph modules. Each module has 12 red and 12 green LEDs inside, for a total of 24 LEDs controlled as a 1x12 matrix. We put two modules on each backpack for a 24-bar long bargraph (48 total LEDs).

This backpack solves the annoyance of using lots of pins or a bunch of chips by having an I2C constant-current matrix controller sit neatly on the back of the PCB. The controller chip takes care of everything, drawing all 48 LEDs in the background. All you have to do is write data to it using the 2-pin I2C interface. There are three address select pins so you can select one of 8 addresses to control up to 8 of these on a single 2-pin I2C bus (as well as whatever other I2C chips or sensors you like). The driver chip can 'dim' the entire display from 1/16 brightness up to full brightness in 1/16th steps. It cannot dim individual LEDs, only the entire display at once.

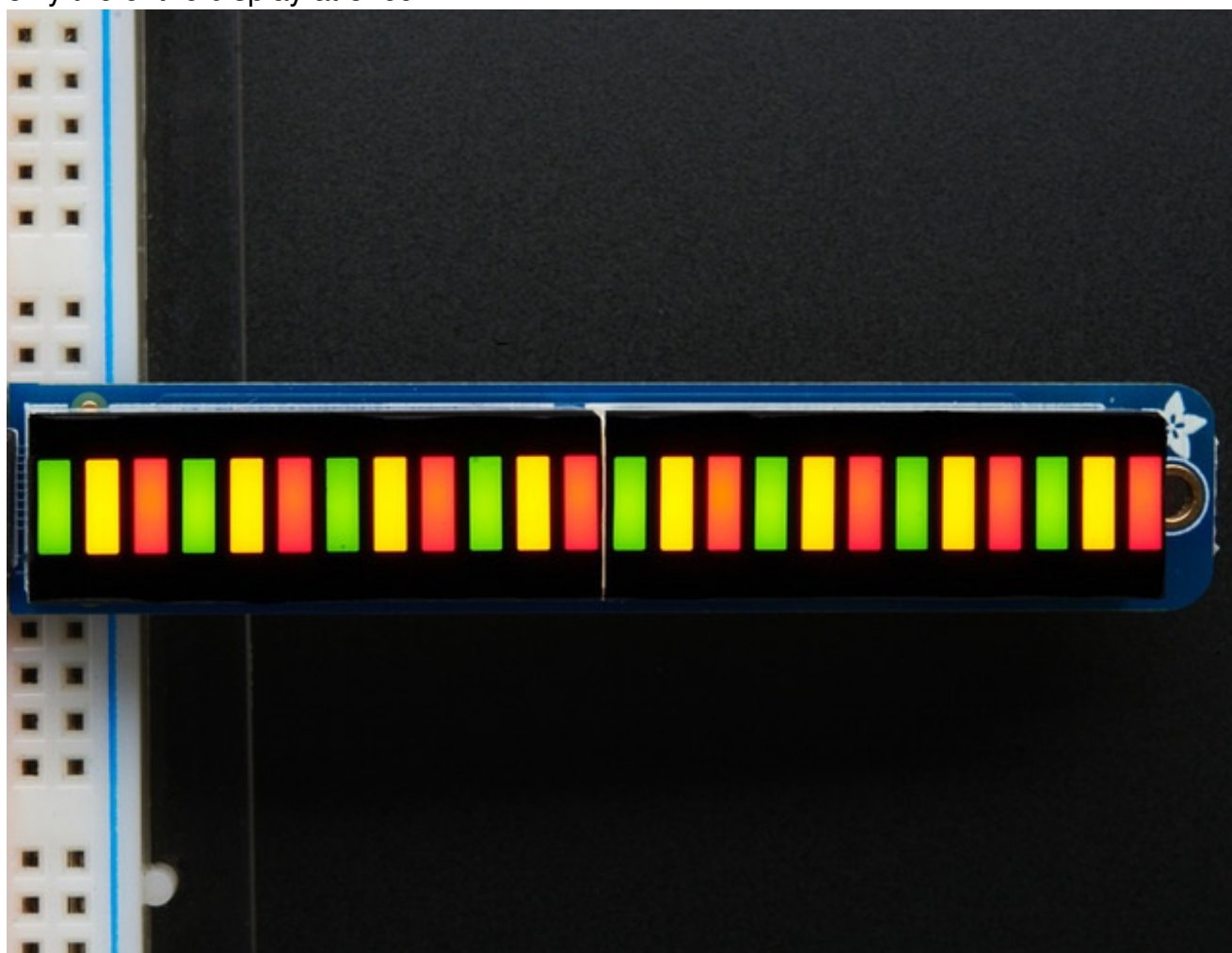

# Attaching the bar-graph modules

Pay close attention to the instructions for positioning the bargraphs. They must be oriented correctly to work and is almost impossible to remove them once soldered to the backpack! Remove the parts from packaging and place the LED bargraphs over the outlines on the top of the PCB.

**The bargraph must be soldered on the correct orientation or it will not work! Check for the side of the bargraph that has printing on it. Then look for the outline on the PCB that has "Text on this side" marked!**

Do not solder the matrix onto the back of the PCB, it won't work either!

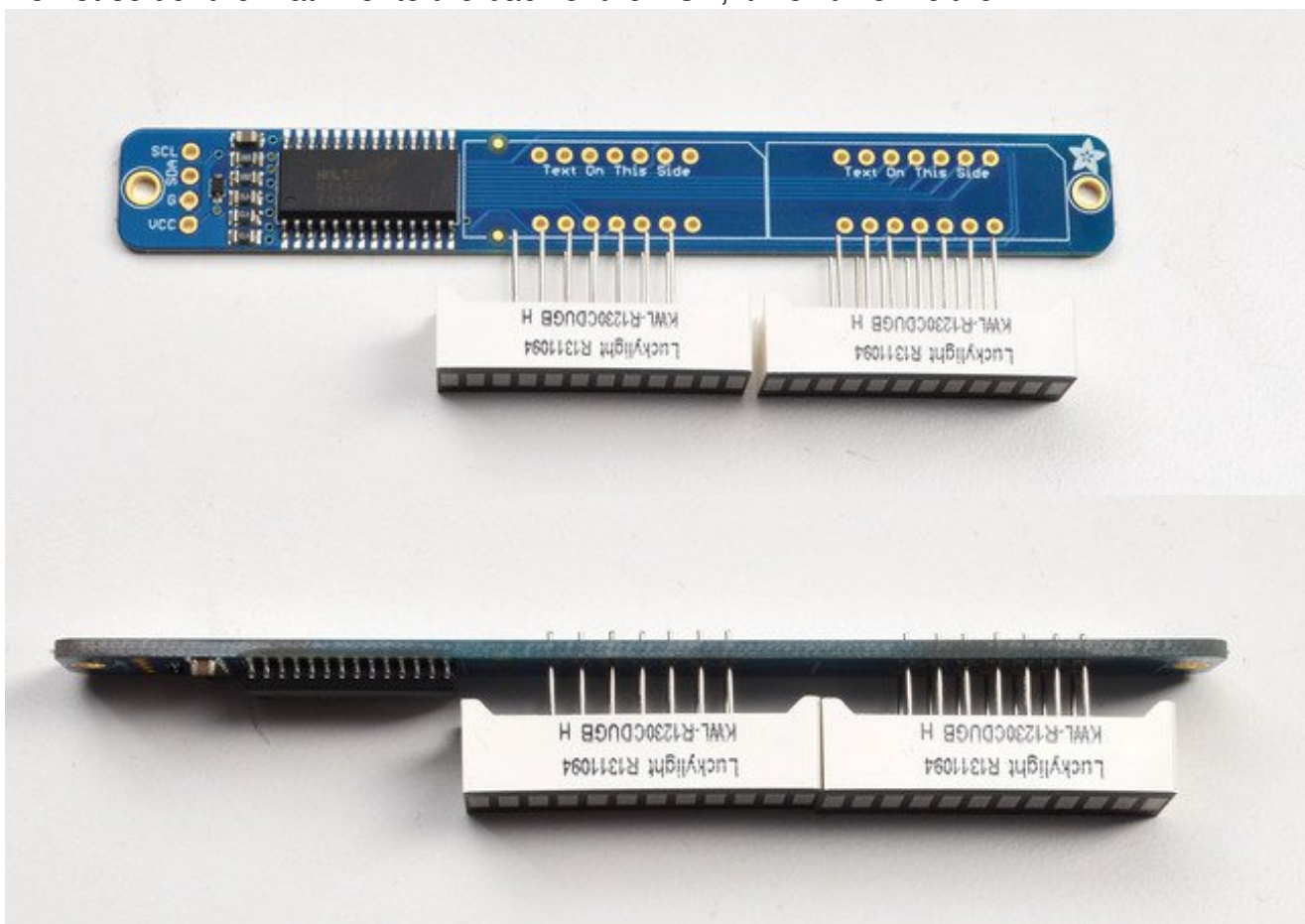

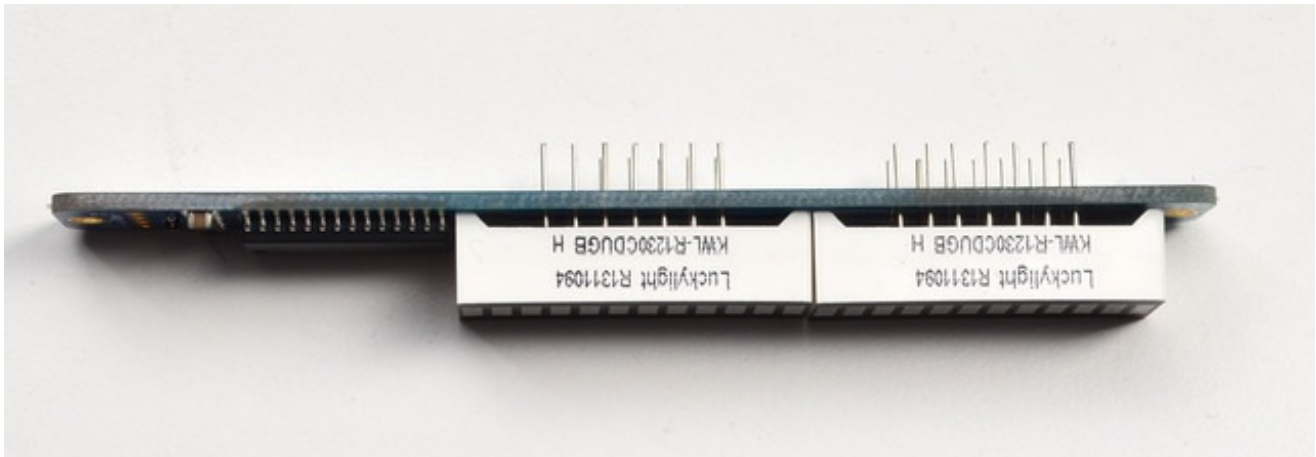

To keep the two bargraphs lined up nicely, you can use a little masking or scotch tape on the bargraph modules, tape them so they are in a straight line. There is a little play during soldering so if you don't do this the two modules may not be in a perfect line.

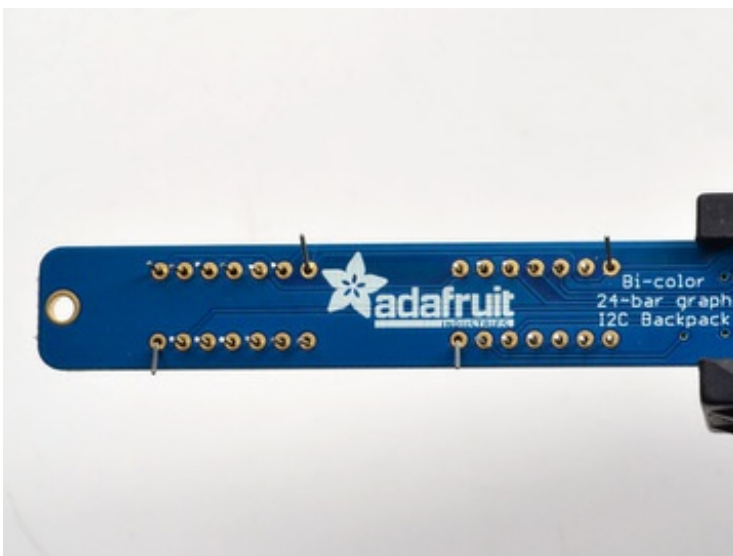
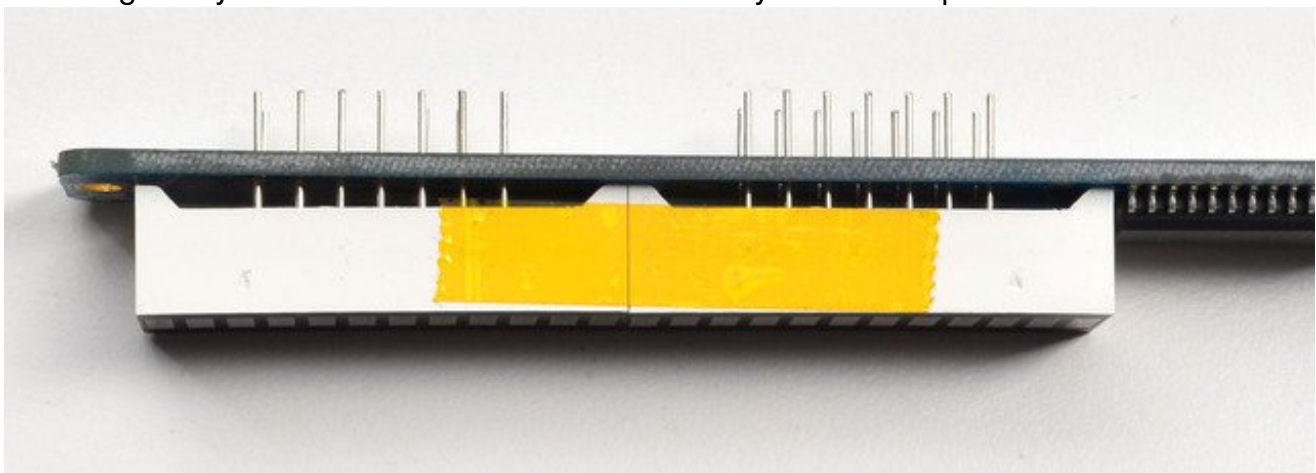

Turn over the PCB and bend opposite-corner pins of the modules out so that the modules are fixed in place against the PCB. Now is a good time to do a last check that you oriented the modules the right way!



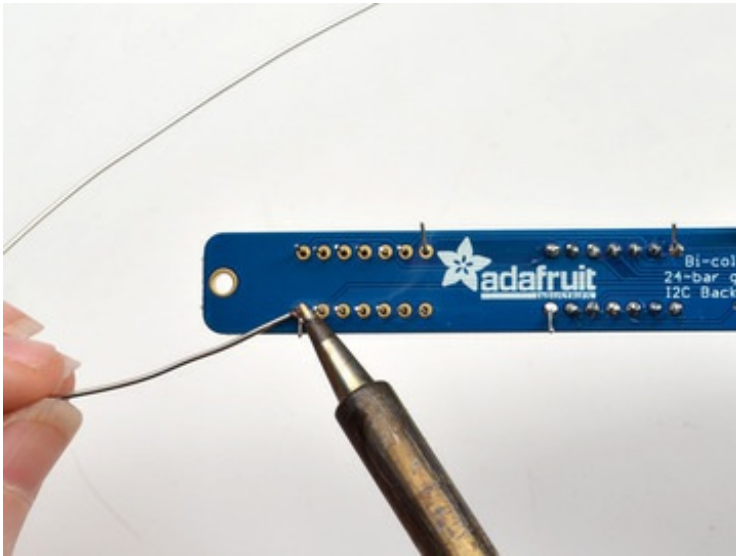
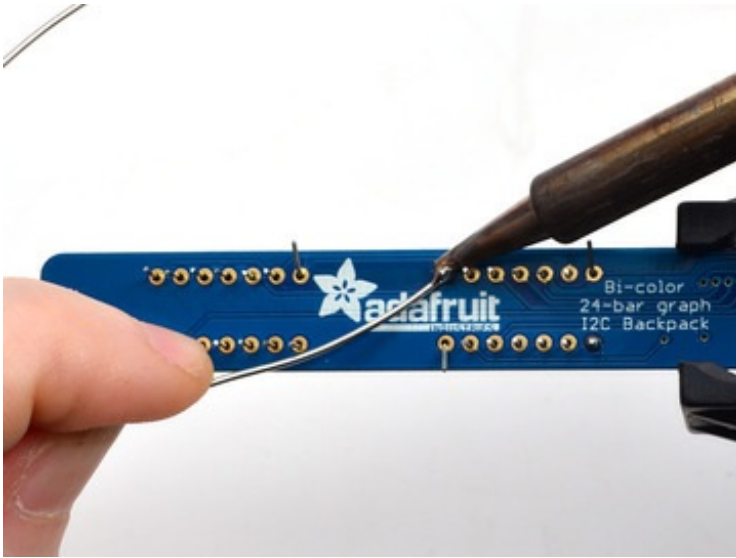
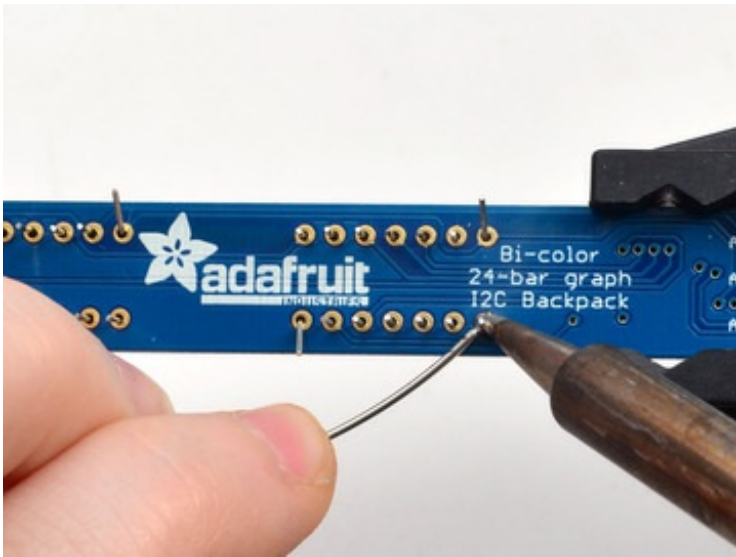

Solder all the module pins in!



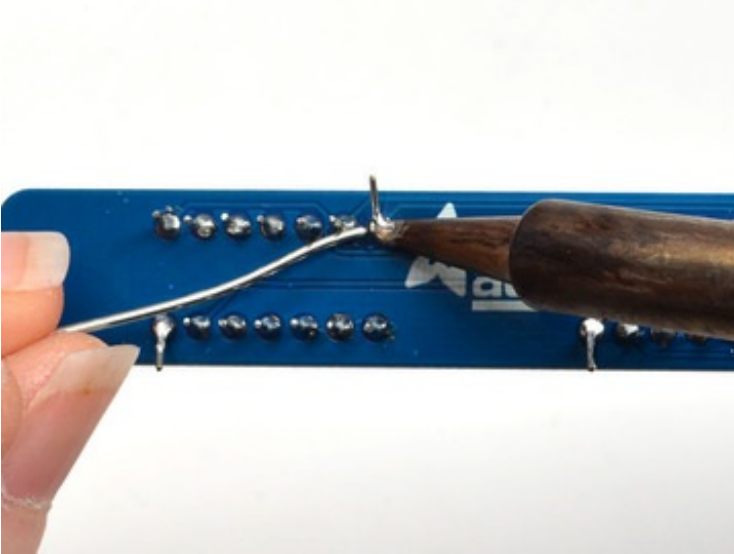

•

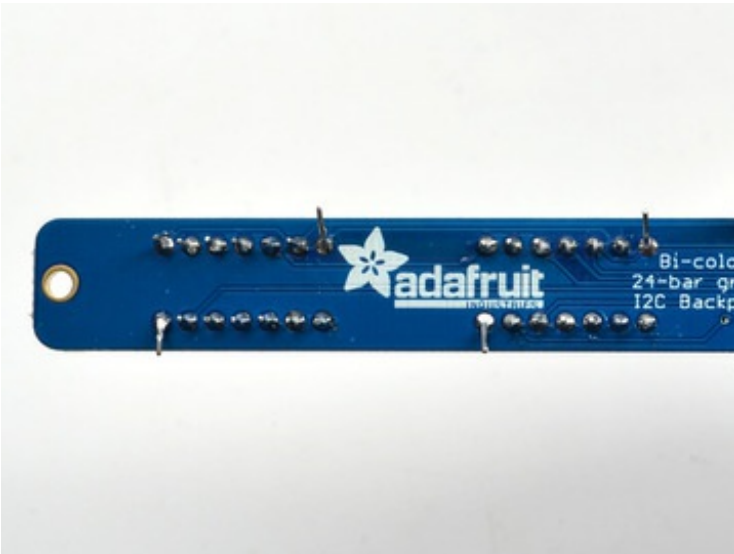

•

OK nice work!

Once soldered, clip each pin. They're quite short and the pins are thicker than usual, so do this over/inside a trash bin so that the pins don't fly off and hit you or your pets.

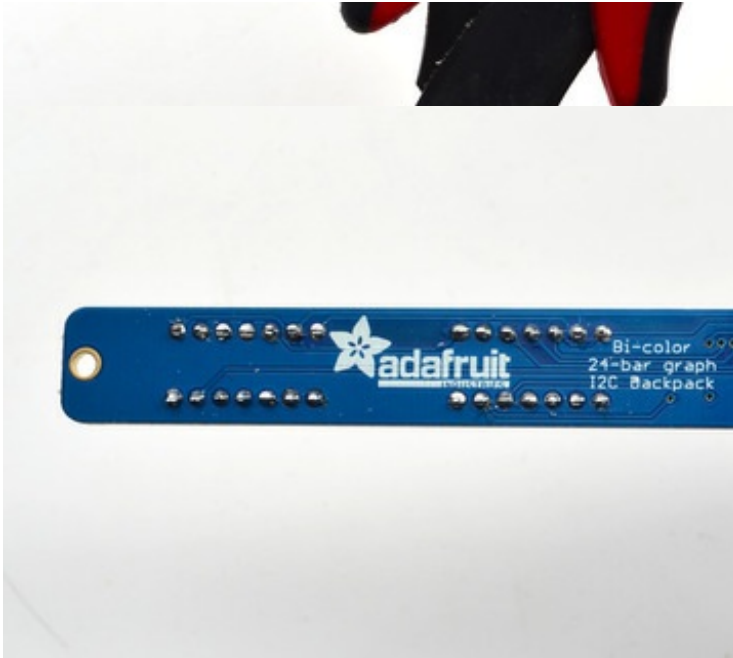

Everything should be neat and clipped, you're done!

- 
- 

## Soldering on breadboard pins

This is an optional step - you only need to do this step if you're planning on using the bargraph in a breadboard. Chances are you may want to solder wires directly to the pads instead, so you can mount the bargraph elsewhere. Anyhow, skip this step if its not for you!

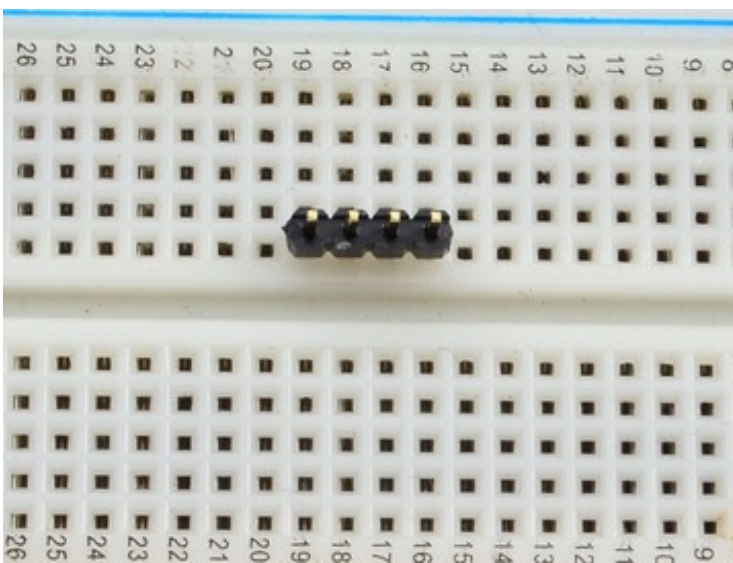

Break off a piece of male header, 4 pins long. Plug the **long ends** into a solderless breadboard.

-

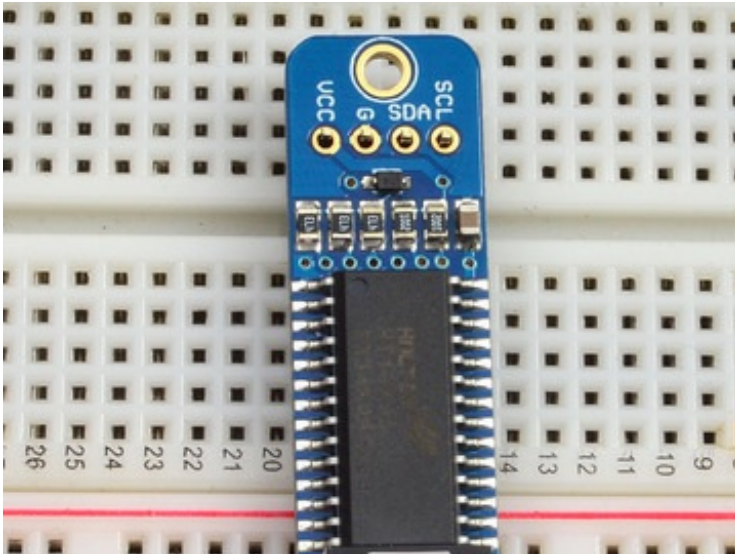

Place the PCB on top. you may need to support it a little since its quite long.

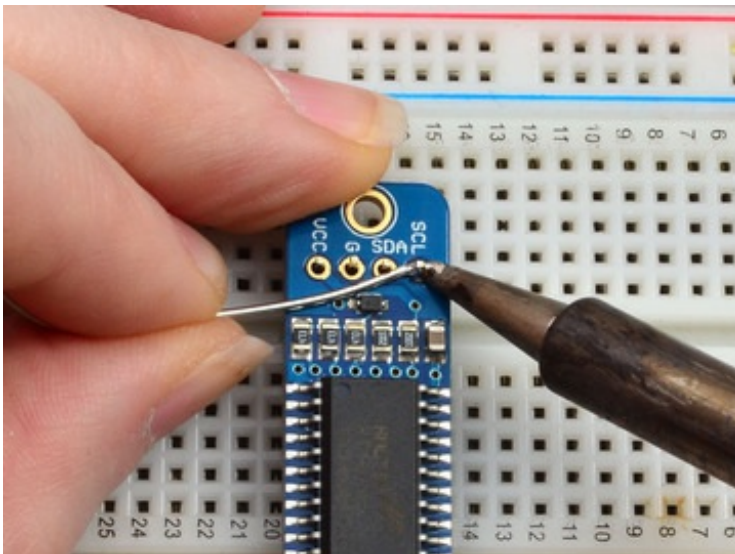

Solder these 4 pins too, since you're good at it now this should be easy.

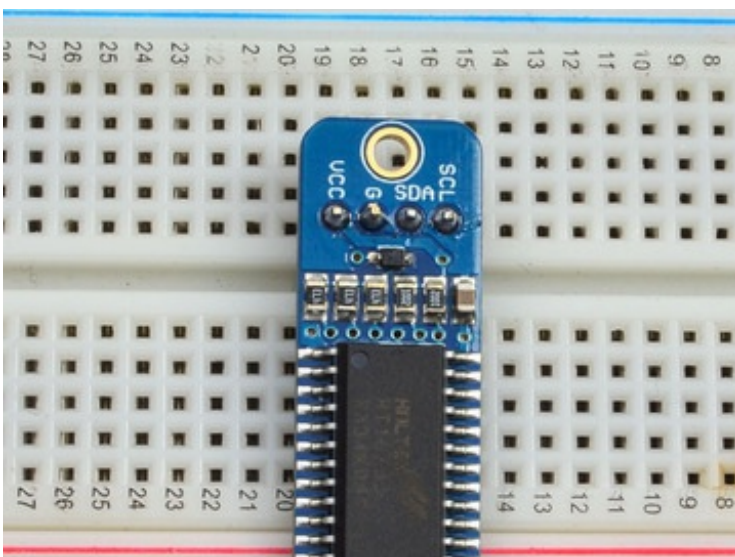

# Bi-Color Bargraph LED Backpack Wiring & Firmware

We wrote a basic library to help you work with the bi-color bargraph backpack. The library is written for the Arduino and will work with any Arduino as it just uses the I2C pins. The code is very portable and can be easily adapted to any I2C-capable micro.

Wiring to the bargraph is really easy

- Connect **SCL** to the I2C clock - on Arduino UNO that's Analog #5, on the Leonardo it's Digital #3, on the Mega it's digital #21
- Connect **SDA** to the I2C data - on Arduino UNO that's Analog #4, on the Leonardo it's Digital #2, on the Mega it's digital #20
- Connect **GND** to common ground
- Connect **VCC** to power - 5V is best but 3V also seems to work for 3V microcontrollers.

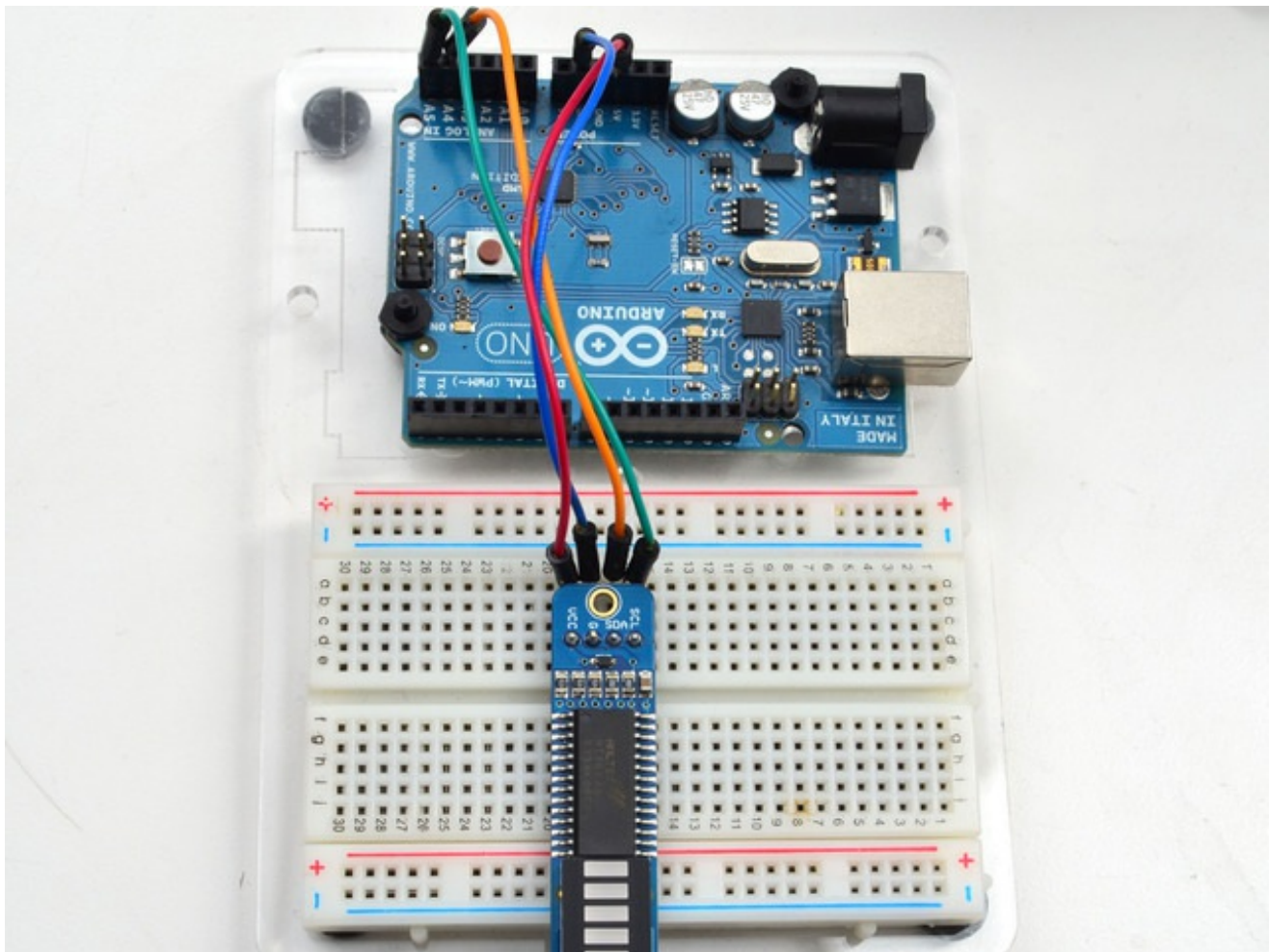



Next, [download the Adafruit LED Backpack library from github \(http://adafru.it/aLI\)](http://adafru.it/aLI) . To download click the DOWNLOADS button in the top right corner, rename the uncompressed folder **Adafruit\_LEDBackpack**. Check that the **Adafruit\_LEDBackpack** folder contains **Adafruit\_LEDBackpack.cpp** and **Adafruit\_LEDBackpack.h** Place the **Adafruit\_LEDBackpack** library folder your *arduinofolder/libraries/* folder. You may need to create the *libraries* subfolder if its your first library. [You'll also need to download the Adafruit GFX library \(http://adafru.it/aJa\)](http://adafru.it/aJa) that provides the graphics drawing routines. Restart the IDE.

Once you've restarted you should be able to select the **File->Examples->Adafruit\_LEDBackpack->bargraph24** example sketch. Upload it to your Arduino as usual. You should see a basic test program that tests all the LEDs with different colors

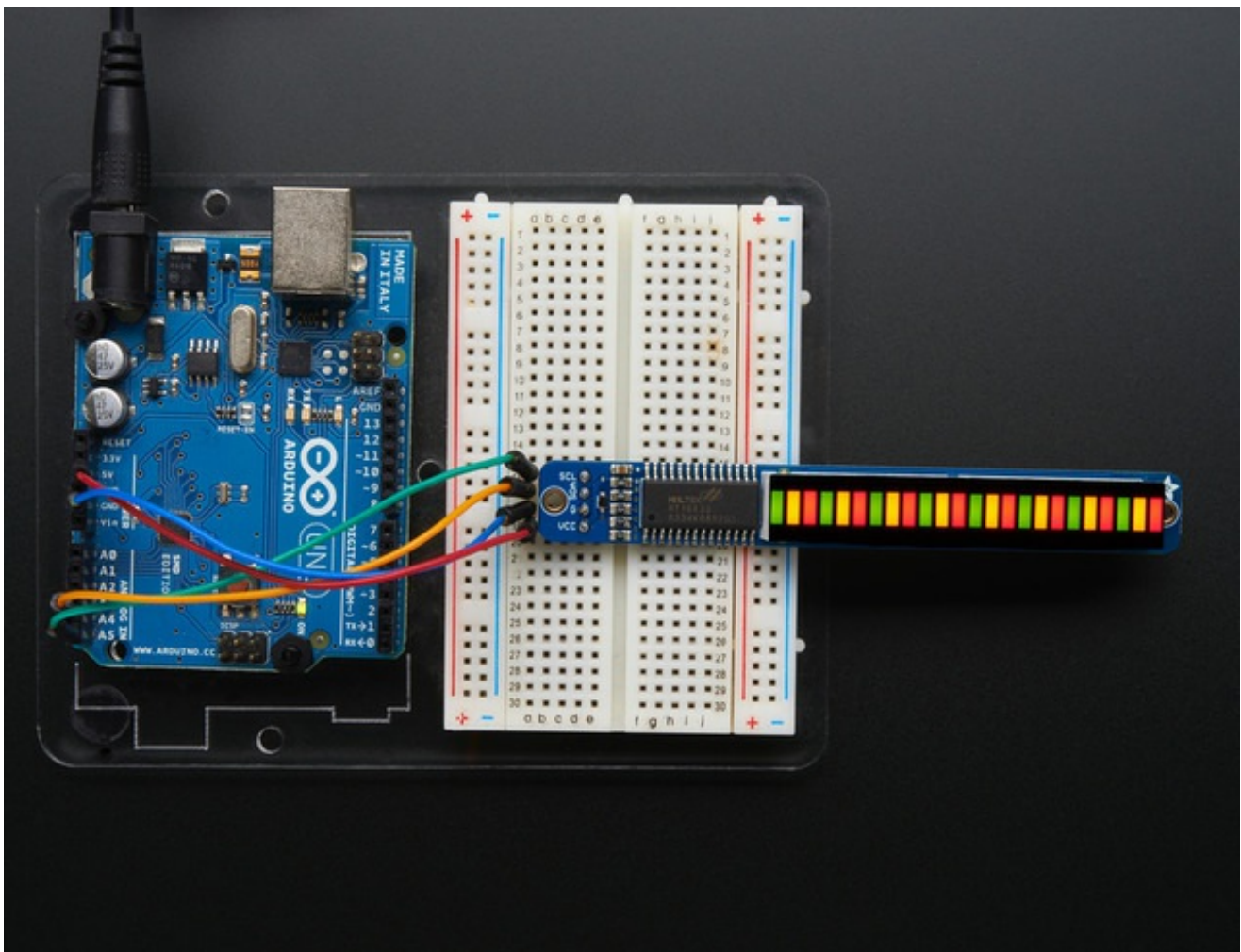

Using the library interface is very easy. Start by creating the object with

```
Adafruit_24bargraph bar = Adafruit_24bargraph();
```

you can name it whatever you want, not just **bar**



Then initialize it with

```
bar.begin(0x70); // pass in the address
```

You can init with any address from 0x70 to 0x77, just make sure you solder in the matching solder jumpers!

Finally, write to the bargraph with

```
bar.setBar(lednumber, ledcolor);
```

Where *lednumber* is 0 thru 23. *ledcolor* can be **LED\_RED**, **LED\_YELLOW**, **LED\_GREEN** or **LED\_OFF**

The drawing routines only change the display memory kept by the Arduino. Don't forget to call **bar.writeDisplay()** after drawing to 'save' the memory out to the matrix via I2C.

There are also a few small routines that are special to the matrix:

- **setBrightness(*brightness*)**- will let you change the overall brightness of the entire display. 0 is least bright, 15 is brightest and is what is initialized by the display when you start
- **blinkRate(*rate*)** - You can blink the entire display. 0 is no blinking. 1, 2 or 3 is for display blinking.

# Connecting Multiple Backpacks

The coolest part about the I2C backpacks is that you can connect more than one using just the same 2 pins. This opens possibilities for [all kinds of multi-display projects](http://adafru.it/aQt) (<http://adafru.it/aQt>).

[For a project that shows this in practice, check out this page](http://adafru.it/aQF) (<http://adafru.it/aQF>) on animating multiple LED backpacks



# Wire it Up

To connect another backpack to your project, just wire it in parallel with the first one as in the diagram below.

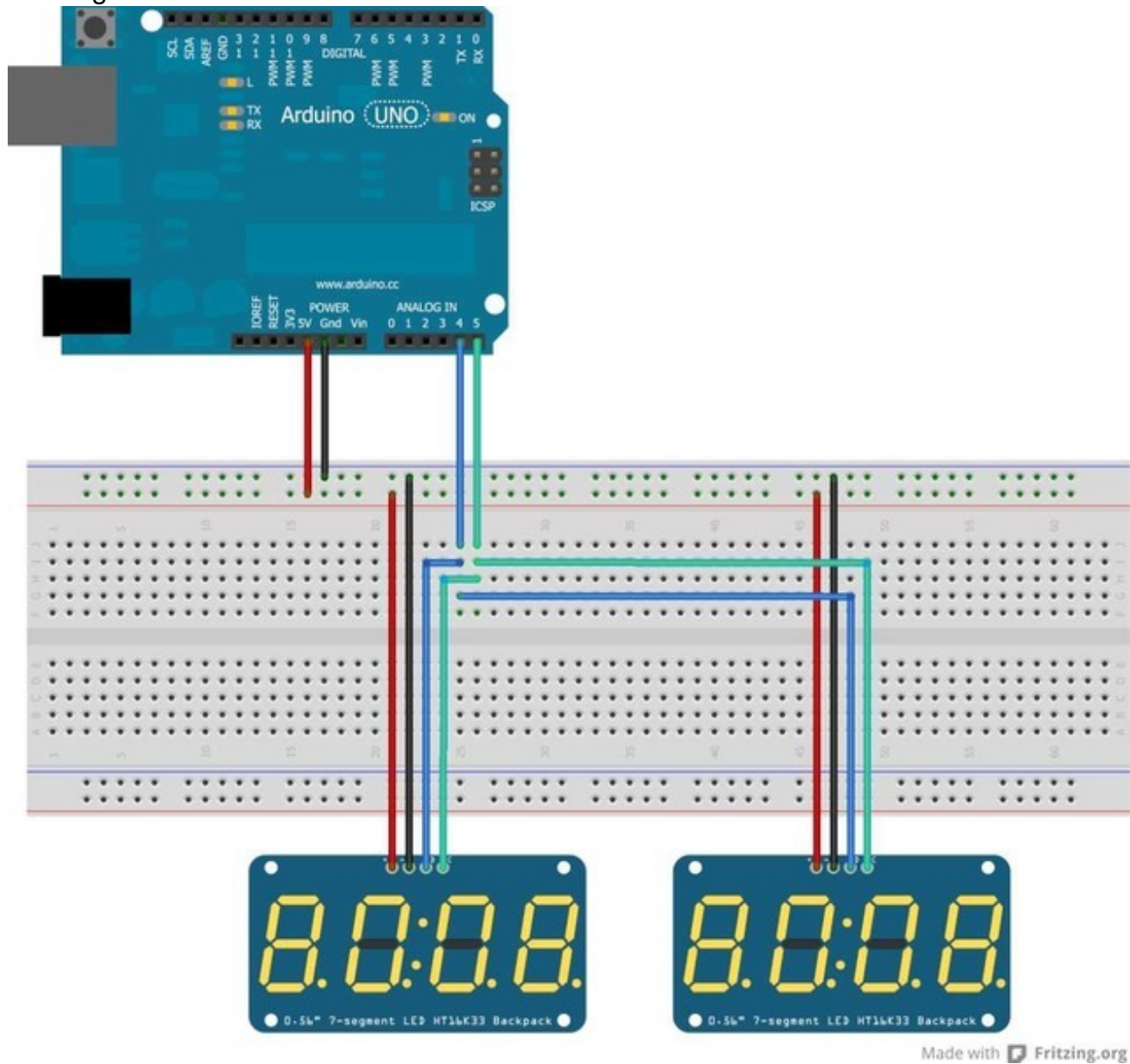

## Configure the Address

For each backpack you add, you need to configure a different I2C address. You can keep adding backpacks in the same way until you run out of addresses. See the next page for how to configure the address on your backpack.





# Changing I2C Address

The HT16K33 driver chip on these LED backpacks has a default I2C address of **0x70**. Since each device on an I2C bus must have a unique address, its important to avoid collisions or you'll get a lot of strange responses from your electronic devices!

Luckily, the HT16K33 has 2 or 3 address adjust pins, so that the address can be changed! The mini 0.8" 8x8 matrix backpack has 2 address adjust pins. The 1.2" 8x8, bi-color 8x8, bi-color bargraph and 4 x 7-segment backpacks have 3 address adjust pins.

That means that you can set the backpacks to these addresses:

- **Mini 0.8" 8x8:** 0x70, 0x71, 0x72, 0x73
- **Small 1.2" 8x8:** 0x70, 0x71, 0x72, 0x73, 0x74, 0x75, 0x76, 0x77
- **4 x 7-segment:** 0x70, 0x71, 0x72, 0x73, 0x74, 0x75, 0x76, 0x77
- **Bi-color 1.2" 8x8:** 0x70, 0x71, 0x72, 0x73, 0x74, 0x75, 0x76, 0x77
- **Bi-color 24-bargraph:** 0x70, 0x71, 0x72, 0x73, 0x74, 0x75, 0x76, 0x77

You can mix-and-match matrices, as long as each one has a unique address!

## Changing Addresses

You can change the address of a backpack very easily. Look on the back to find the two or three **A0, A1 or A2** solder jumpers. Each one of these is used to hardcode in the address. If a jumper is shorted with solder, that sets the address. **A0** sets the lowest bit with a value of **1**, **A1** sets the middle bit with a value of **2** and **A2** sets the high bit with a value of **4**. The final address is **0x70 + A2 + A1 + A0** So for example if **A2** is shorted and **A0** is shorted, the address is **0x70 + 4 + 1 = 0x75**. If only A1 is shorted, the address is **0x70 + 2 = 0x72**

**A2** does not appear on the mini 0.8" 8x8 matrix, so you cannot set the address higher than 0x73

On the 1.2" 8x8 backpacks, the labels for A1 and A2 are swapped! Sorry about that!



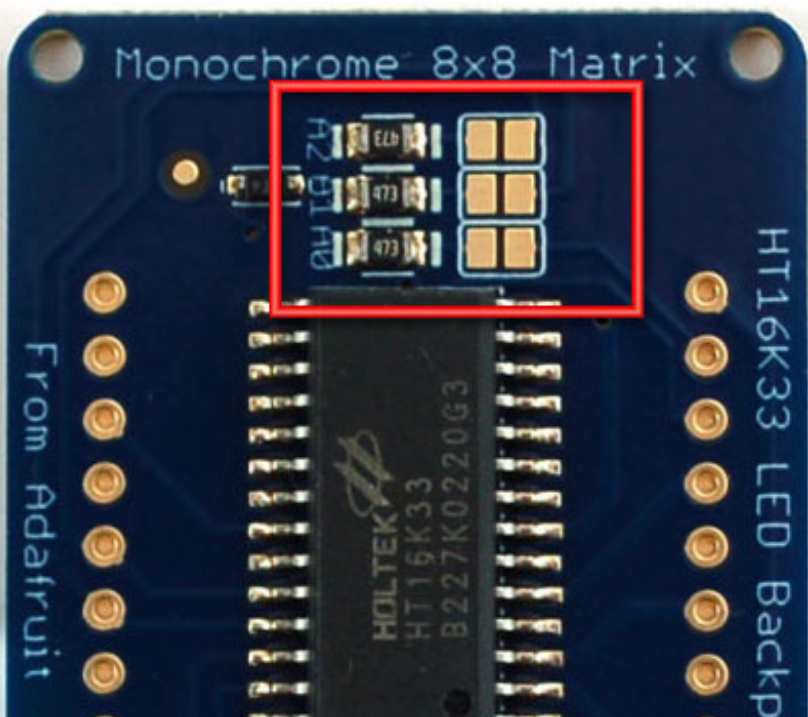
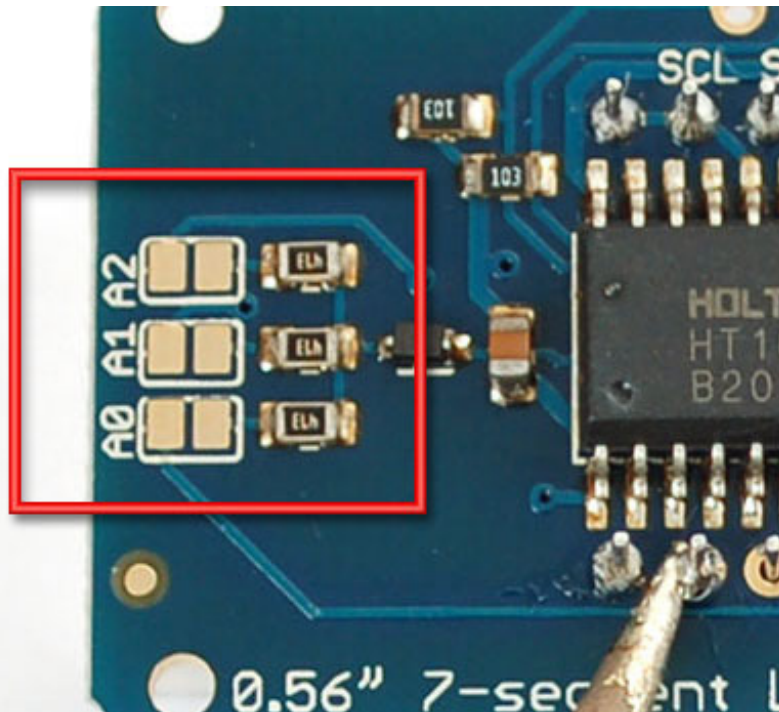

## Changing the address in your code

Once you've adjusted the address on the backpack, you'll also want to adjust the address in the code!

For the Arduino library we wrote, its simple. For example, lets say you want to have two seven-segment matrices. One is set to address 0x70 and the other is set to 0x71. Find this code in the example

```
Adafruit_7segment matrix = Adafruit_7segment();

void setup() {
  Serial.begin(9600);
  Serial.println("7 Segment Backpack Test");

  matrix.begin(0x70);
}
```

And change it to this:

```
Adafruit_7segment matrix1 = Adafruit_7segment();
Adafruit_7segment matrix2 = Adafruit_7segment();

void setup() {
  Serial.begin(9600);
  Serial.println("Double 7 Segment Backpack Test");

  matrix1.begin(0x70);
  matrix2.begin(0x71);
}
```

That is, instantiate two matrix objects. Then one is called with **begin(0x70)** and the other is called with **begin(0x71)**. Each one can be used individually. If you need more matrices, just instantiate more objects at the top and **begin()** each one with the unique i2c address.



## F.A.Q.

I want to use these modules with other non-Arduino, how can I port the code?

The best way to get up and running is to read the HT16K33 driver datasheet available at <http://learn.adafruit.com/adafruit-led-backpack/downloads> (<http://adafru.it/aMx>) - the backpacks all use this chip to do all the LED driving. You can cross-reference this document with the Arduino library code to adapt it to your platform. Any microcontroller that has I2C host support should be able to drive the backpacks but we only provide Arduino example code at this time

I'd like to use these backpacks with Python / Linux (e.g. a Raspberry Pi)

You're in luck! We have a full tutorial here that covers using the 7-segment and 8x8 matrices on a Pi with Python code -> <http://learn.adafruit.com/matrix-7-segment-led-backpack-with-the-raspberry-pi> (<http://adafru.it/aPj>)

I am having strange problems when combining Adafruit Motor Shield/Servo Shield (PCA9685 based) with the Adafruit LED Matrix/7Seg Backpacks

We are not sure why this occurs but there is an address collision even though the addresses are different! Set the backpacks to address 0x71 or anything other than the default 0x70 to make the issue go away



# Downloads

## Software

[Download the Adafruit LED Backpack library from github \(http://adafru.it/aLI\)](http://adafru.it/aLI) - This code provides support for the mini 8x8, 1.2" 8x8, 7-segment, bargraph, alphanumeric and bicolor LED matrix backpacks.

To download click the ZIP download button, rename the uncompressed folder **Adafruit\_LEDBackpack**. Check that the **Adafruit\_LEDBackpack** folder contains **Adafruit\_LEDBackpack.cpp** and **Adafruit\_LEDBackpack.h** Place the **Adafruit\_LEDBackpack** library folder your *arduinofolder/libraries/* folder.

You may need to create the *libraries* subfolder if its your first library.

[You'll also need to download the Adafruit GFX library \(http://adafru.it/aJa\)](http://adafru.it/aJa) - its not actually used for the 7-segment, its only for the matrix backpacks but its still required. Install just like the library above. Restart the IDE

## Files

- [Fritzing objects in Adafruit Fritzing library \(http://adafru.it/aP3\)](http://adafru.it/aP3)
- [EagleCAD PCB files for all backpacks in GitHub \(http://adafru.it/aLJ\)](http://adafru.it/aLJ)
- [The backpacks all use the HT16K33 chip solely for LED driving \(http://adafru.it/aMy\)](http://adafru.it/aMy) - the mini 8x8's use the 24 pin version and the others use the 28 pin vesion

## HT16K33 8x16 LED Backpack Breakout

Schematic & fabrication print

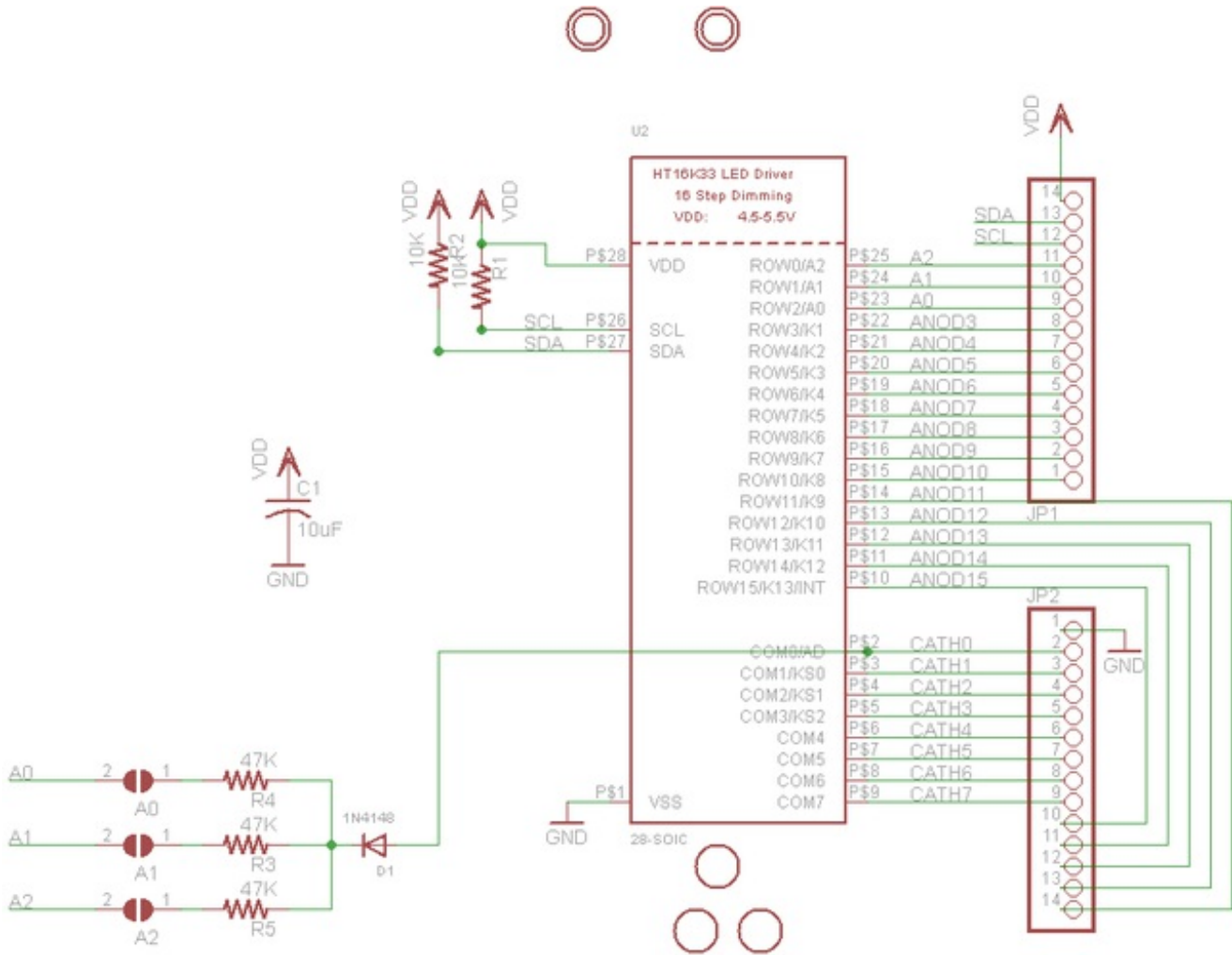



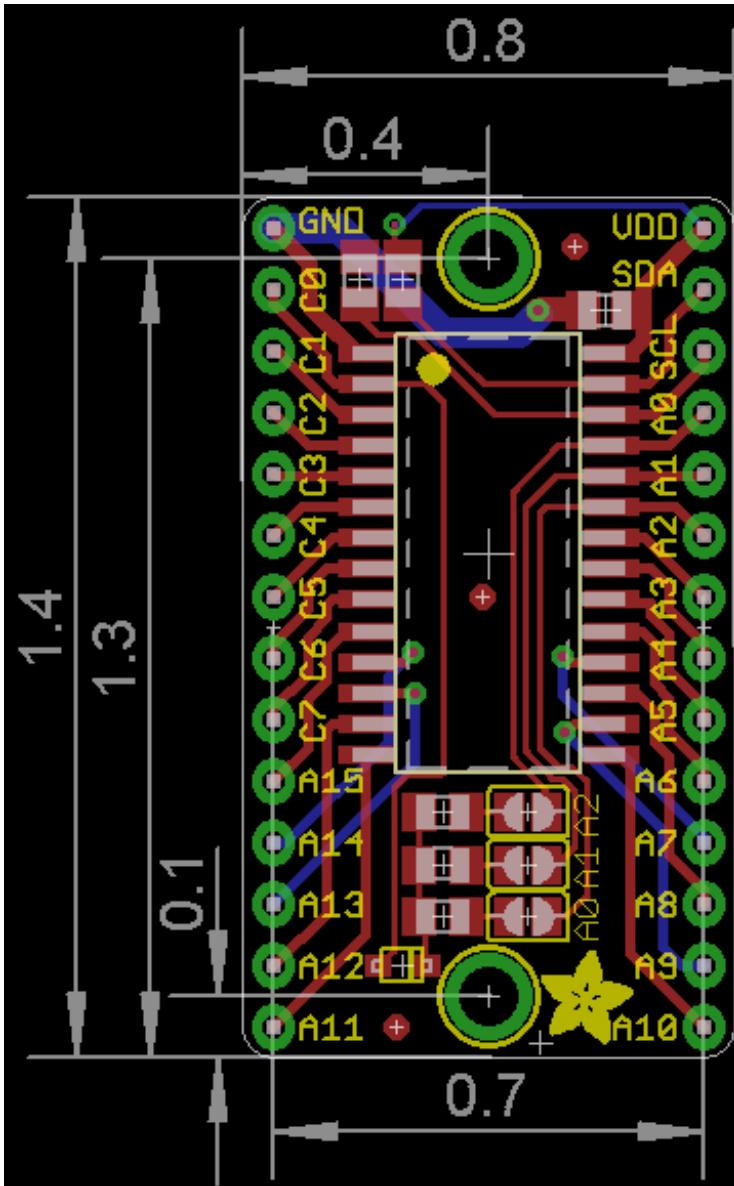

## 8x8 0.8" LED Backpack

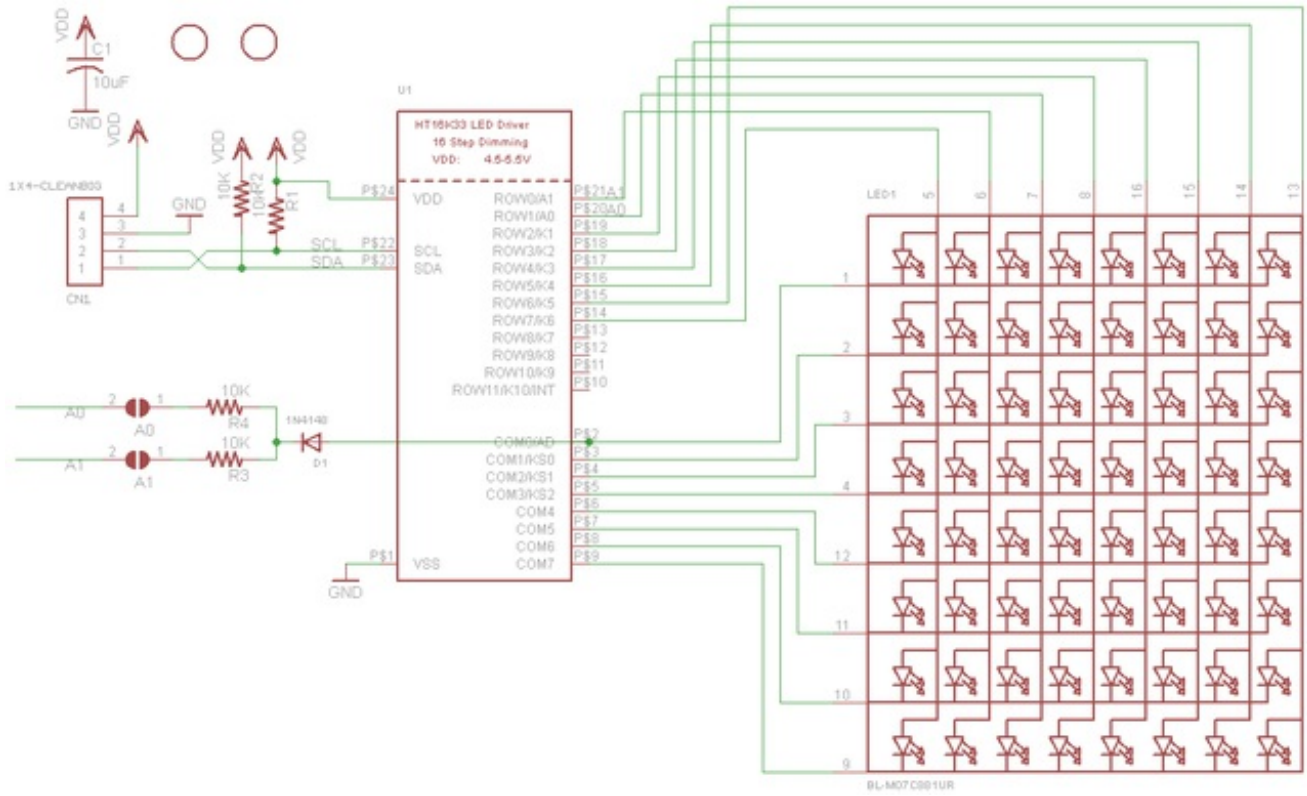

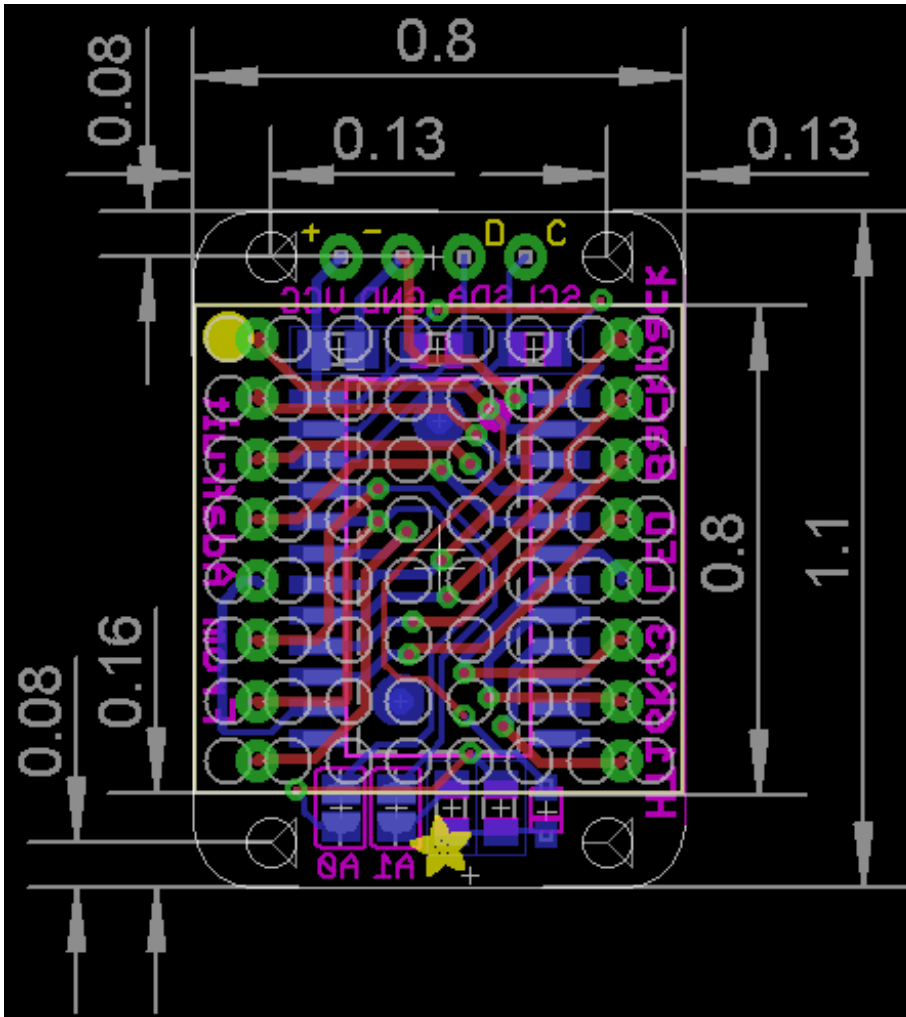

## 8x8 1.2" LED Backpack

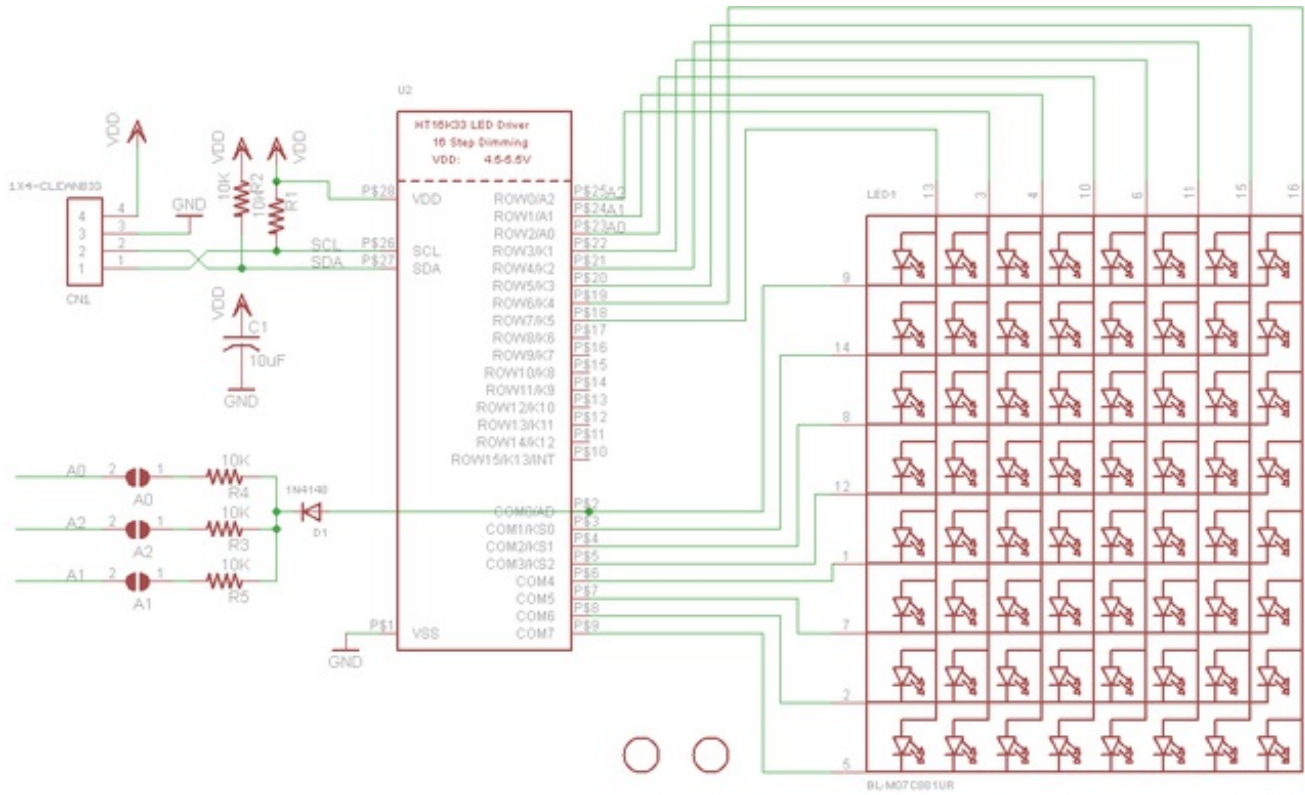

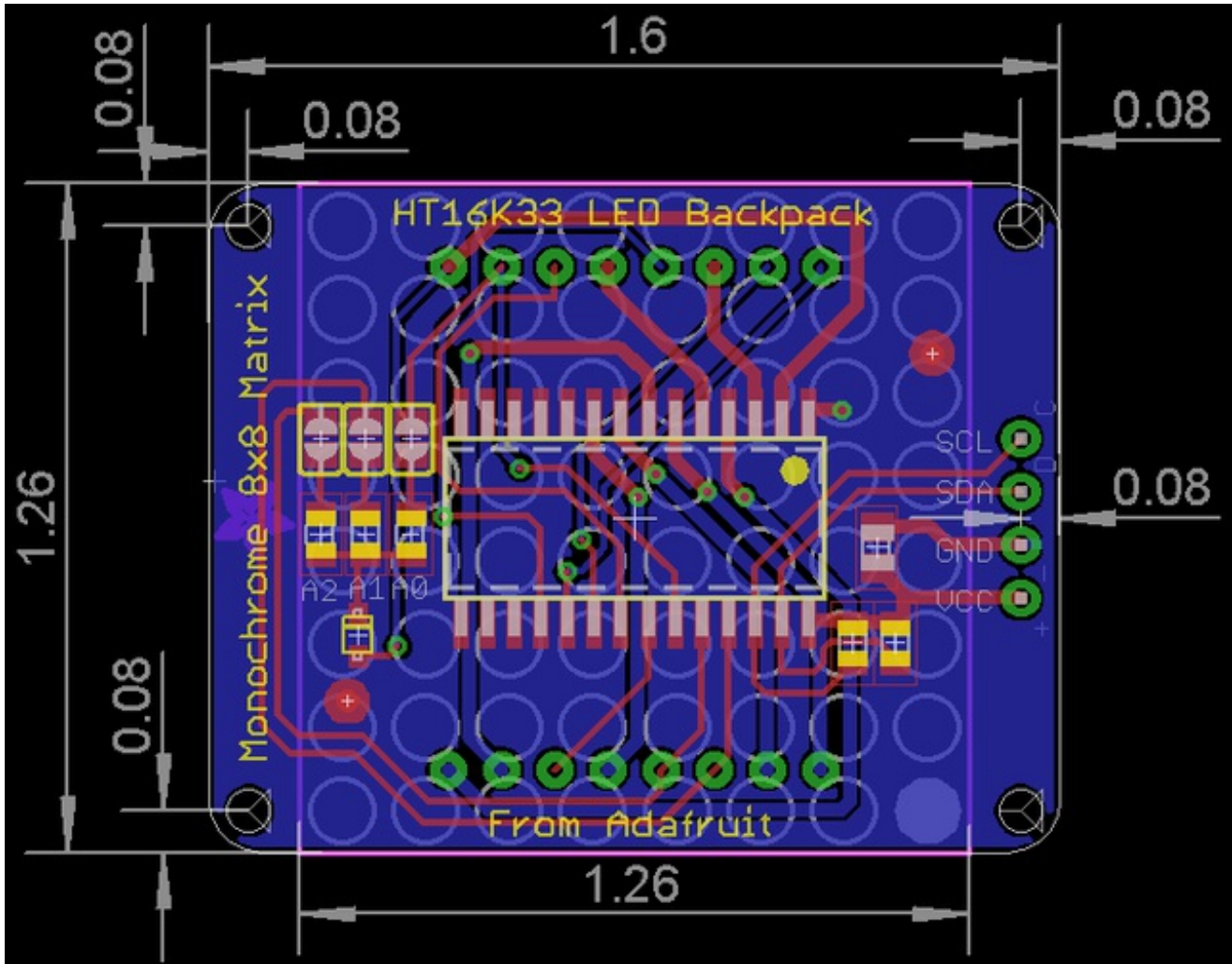

## 8x8 1.2" Bi-Color LED Backpack

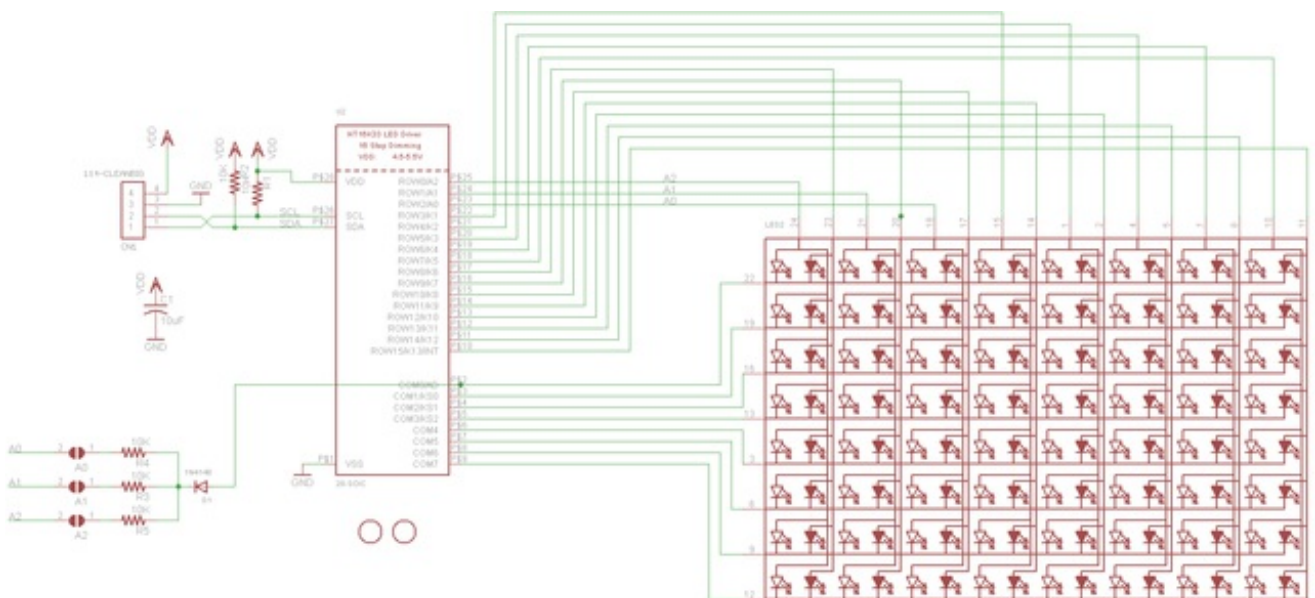



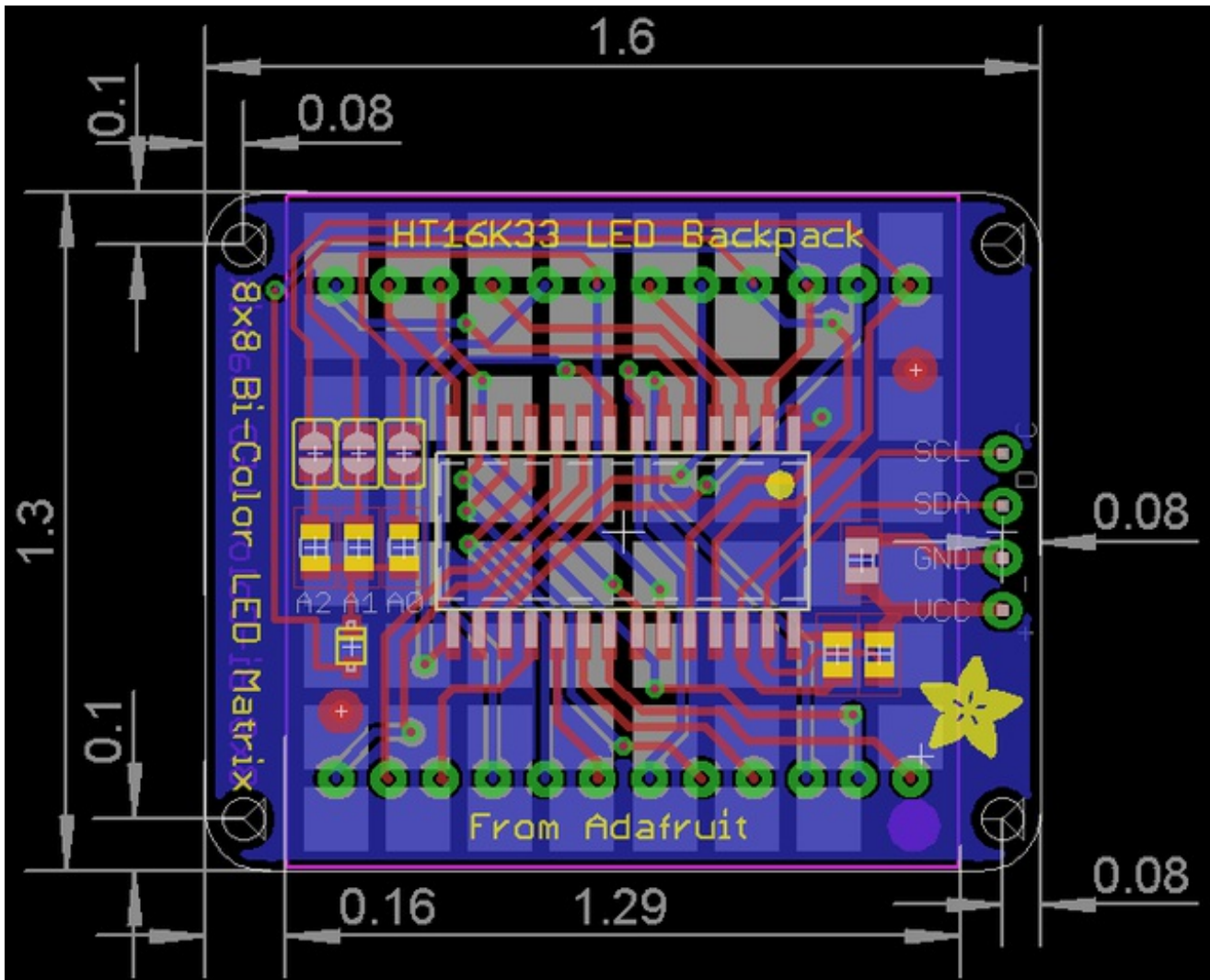

## 16x8 1.2" LED Backpacks

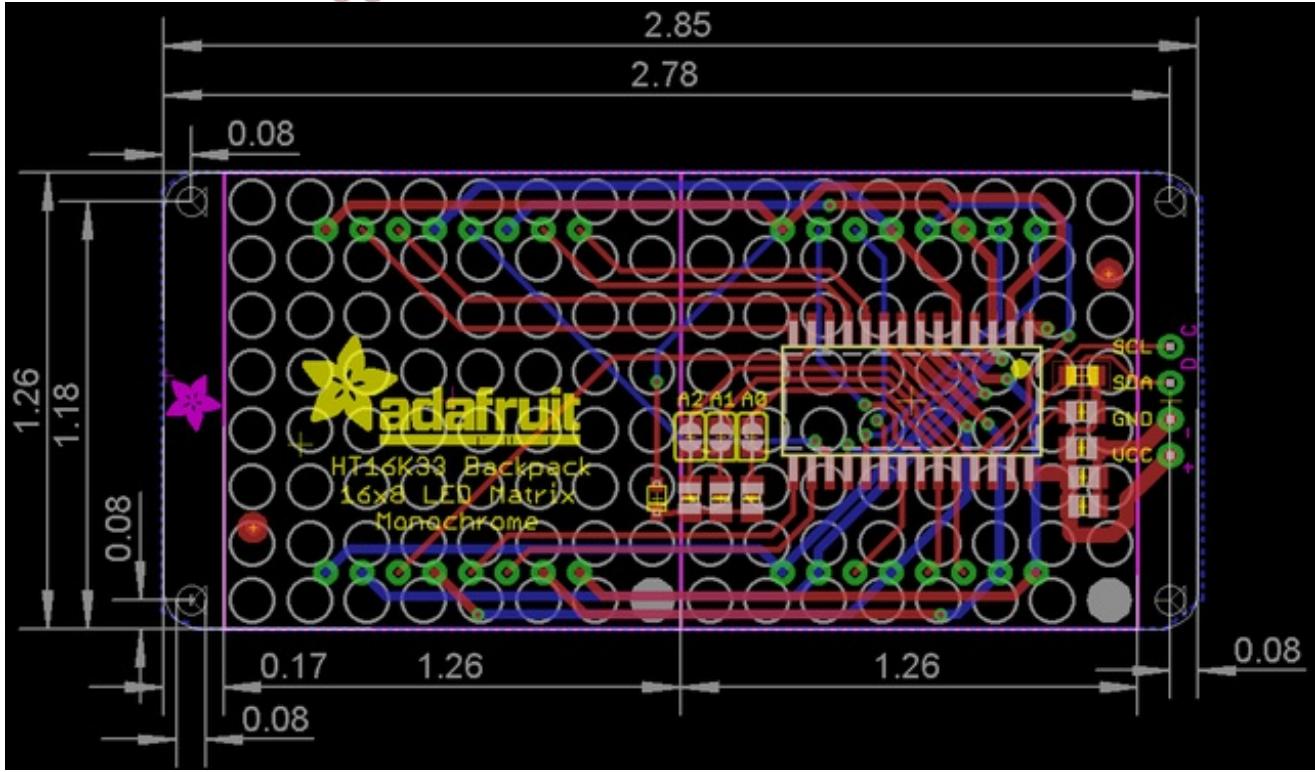
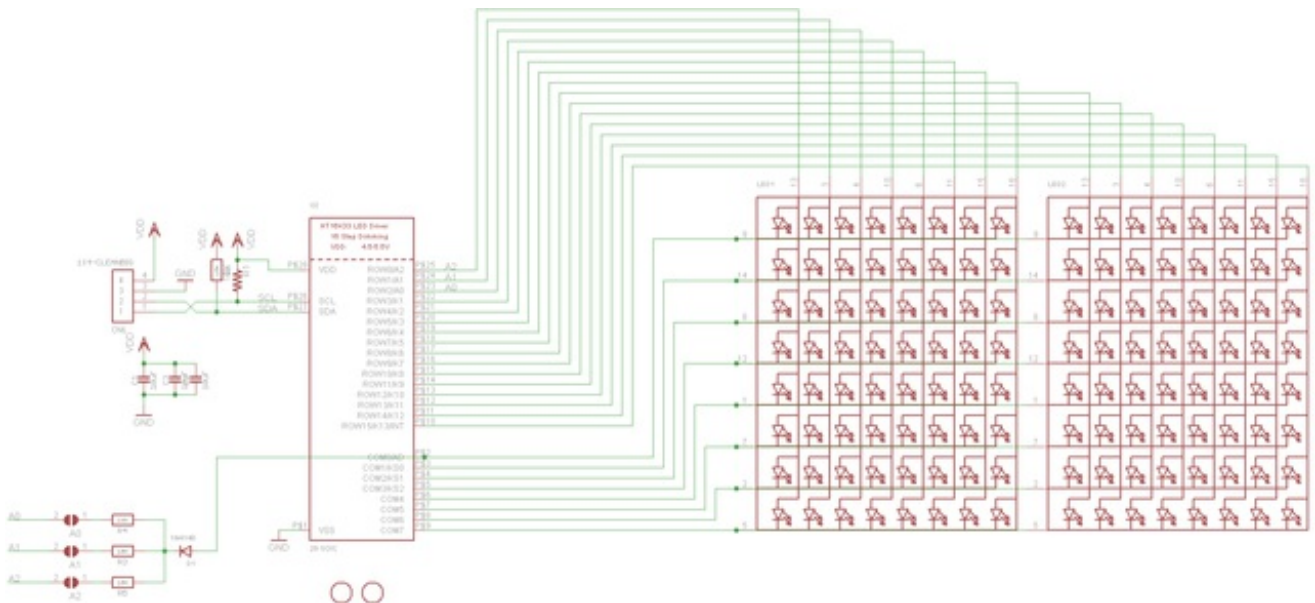

# Quad 0.56" 7-Segment

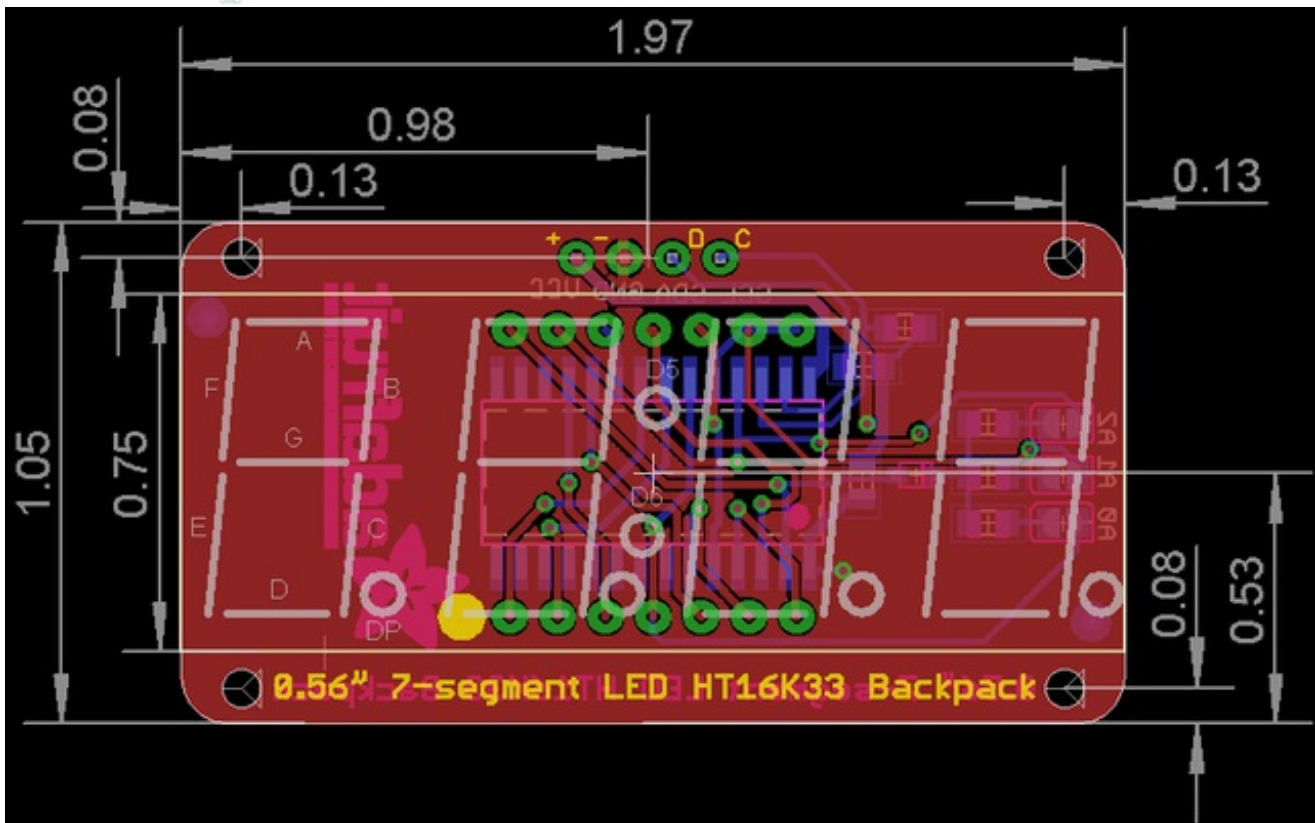
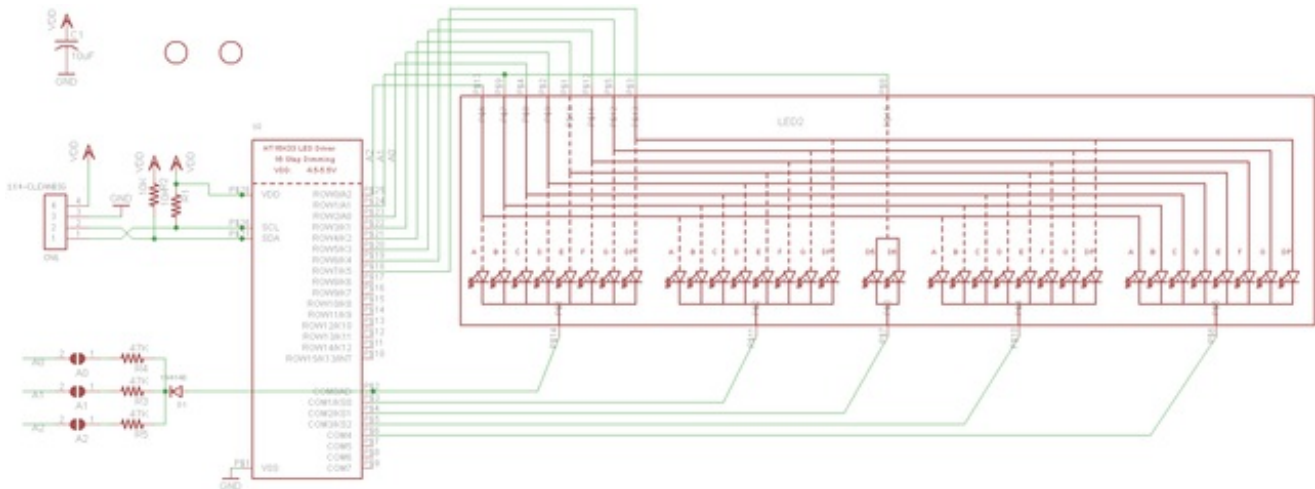

## Quad 0.54" 14-segment Alphanumeric



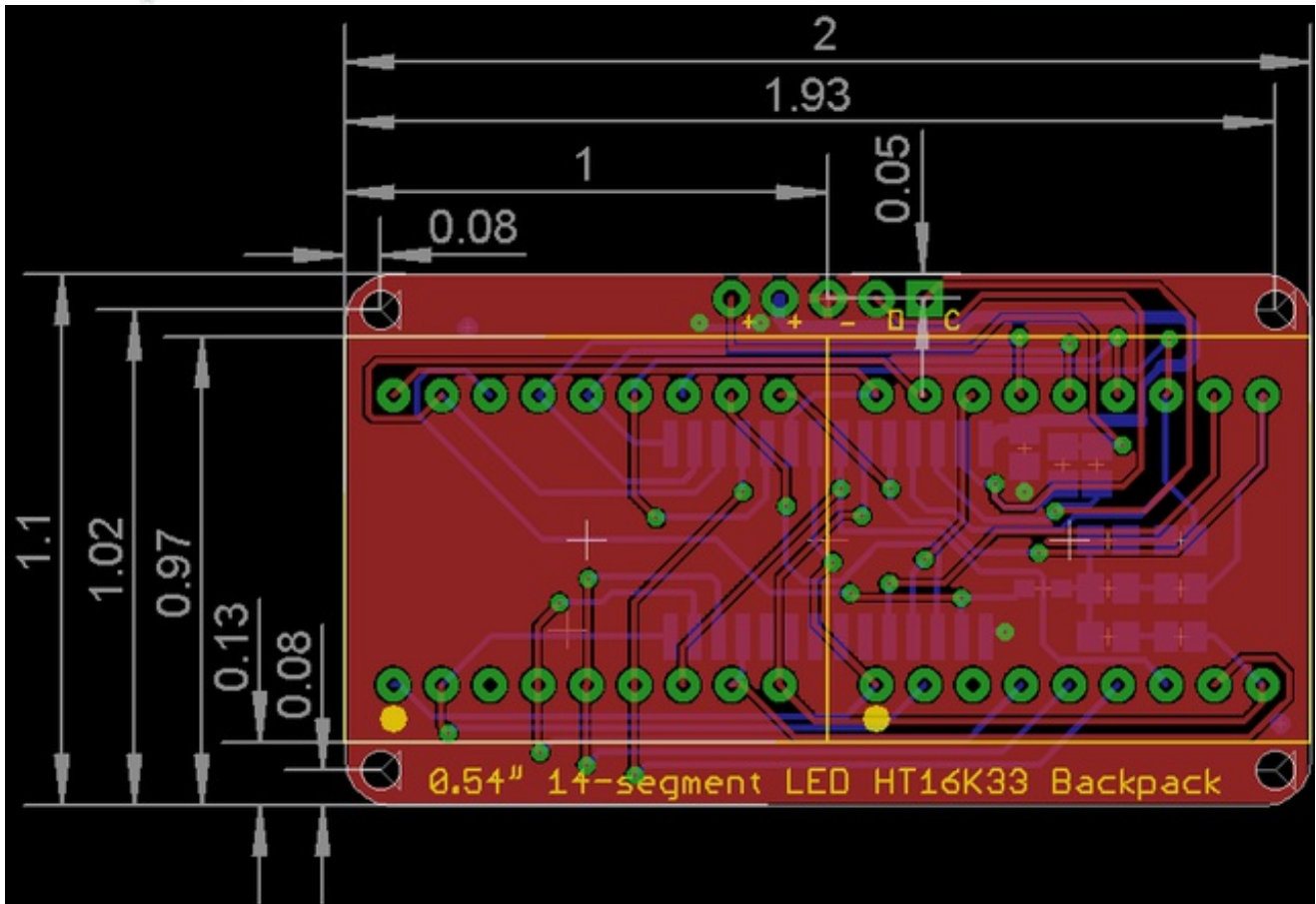
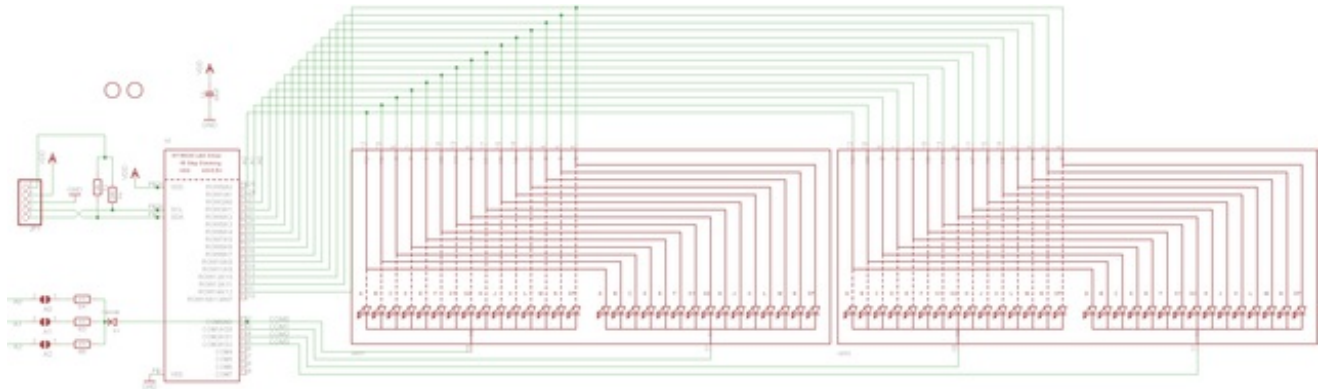

## Quad 1.2" 7-Segment

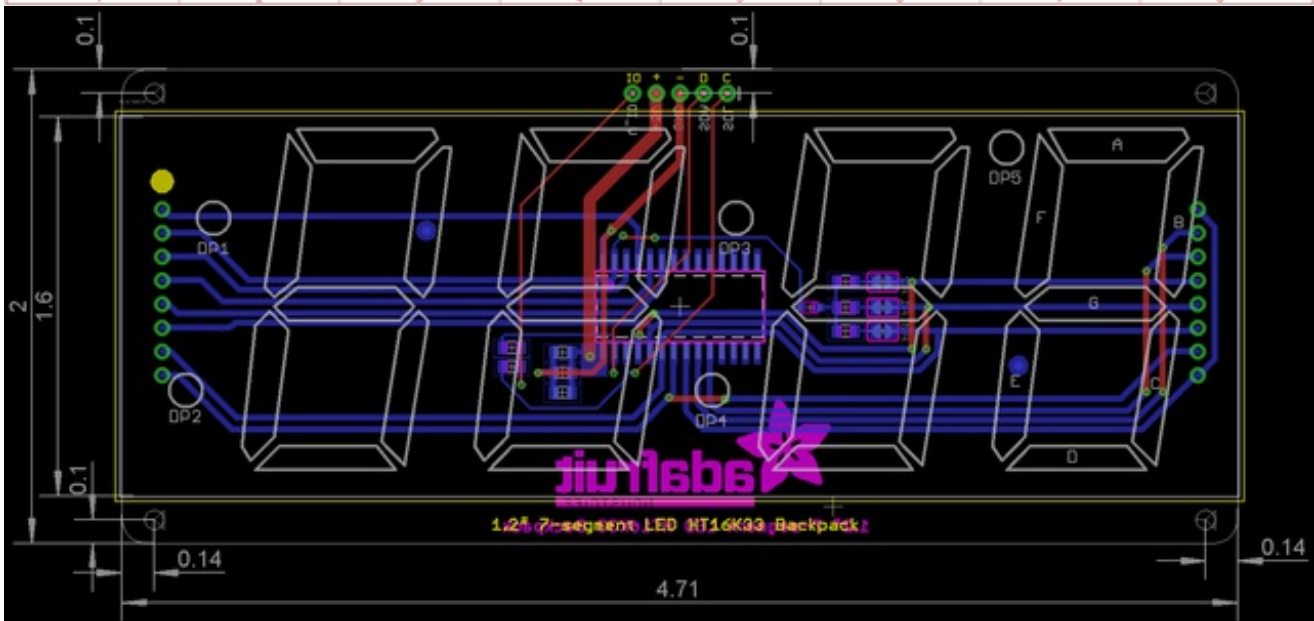
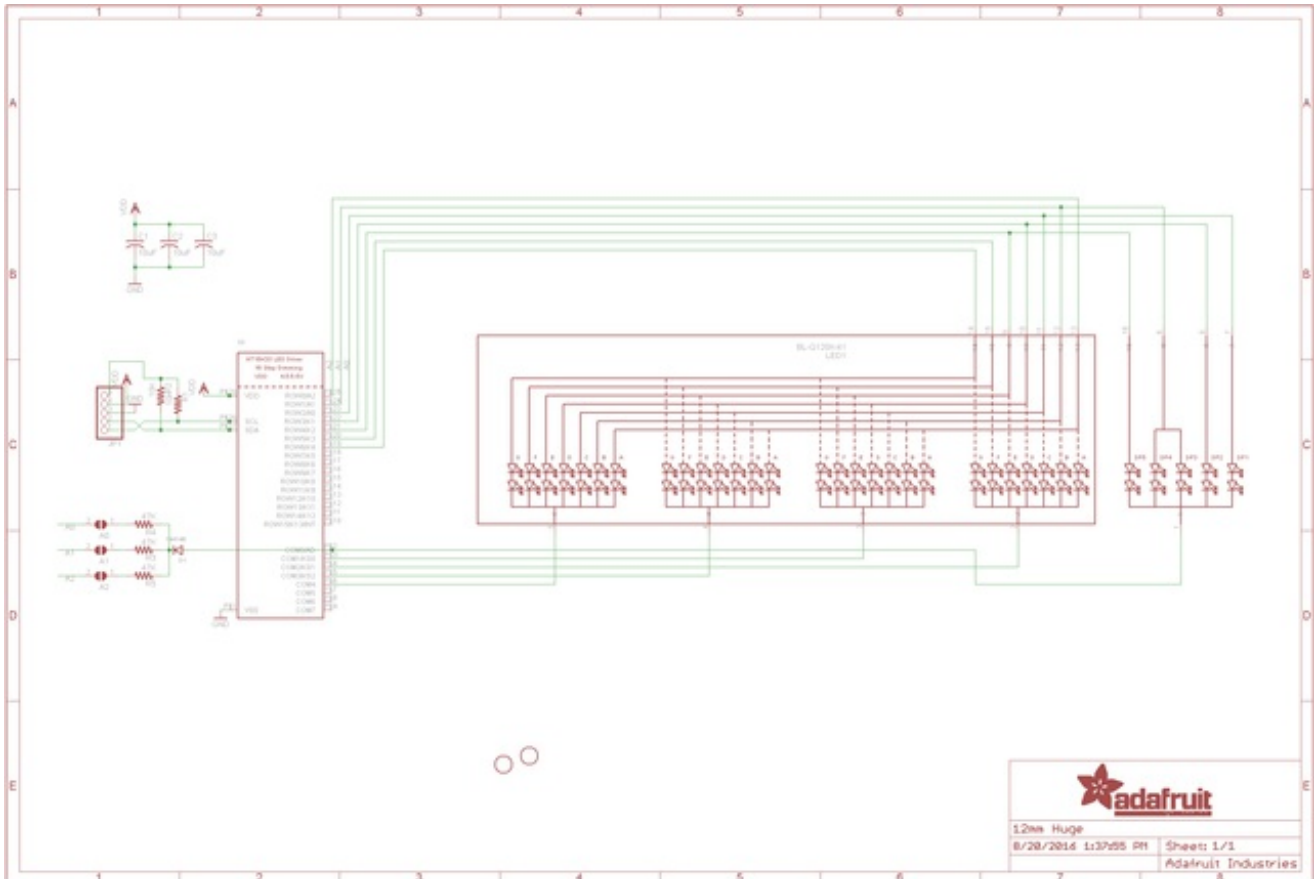

# Bicolor 24-Bargraph



